



 *texi*®

Culture of Sewing



texi Dress form

TEXI DRESS FORM 36-42

TEXI DRESS FORM 42-48



PRICE & INFO
www.strima.com/s1029

Adjustment range	36 - 42	42 - 48
neck girth	35 - 46 cm	35 - 46 cm
bust girth	84 - 100 cm	101 - 117 cm
waist girth	64 - 80 cm	77 - 97 cm
hip girth	86 - 102 cm	102 - 119 cm

How to check the product PRICE & INFO?

You have 3 options



TABLE OF CONTENTS

CUTTING	4
INDUSTRIAL SEWING MACHINES	8
SPECIALIZED MACHINES	32
INDUSTRIAL ACCESSORIES	34
NEEDLES FOR INDUSTRIAL MACHINES	40
NEEDLES FOR HOUSEHOLD SEWING MACHINES	42
HOUSEHOLDSEWING MACHINES	48
HOUSEHOLD ACCESSORIES	66
PATCHWORK	82
IRONING	86
FASTENING	92

texi Titanium Scissors

- ✓ Blades surface hardened with titanium
- ✓ Maximum resistance
- ✓ Lifetime guarantee
- ✓ Soft grip



PRICE & INFO
www.strima.com/s1014



TI700

7" (18 cm) Titanium coated, professional dressmaker shears



7.25 € NET

TI914

9 1/4" (23,5 cm) Titanium coated, professional dressmaker shears



TI613 CRAFT

6 1/3" (16 cm) Titanium coated scissors for upholstery



TI514

5 1/4" (13 cm) Titanium coated hobby - craft scissors



TI814

8 1/4" (21 cm) Titanium coated, professional dressmaker scissors



TIDU0850

Ti 514 + Ti 814 Titanium coated dressmaker shears 8 1/4" (21 cm) and hobby - craft scissors 5 1/4" (13 cm)

texi Titanium

soft grip



CUTTING



WATCH A VIDEO ABOUT
texi Titanium



texi. Round knife cutters



PRICE & INFO
www.strima.com/i4Nkd



PRICE & INFO
www.strima.com/i4Sb1

TEXI ZORRO 100

Round knife with AC Servo motor



27 MM



- blade diameter 100 mm
- direct drive AC Servo motor
- 5-step speed regulation
- cutting height 27 mm
- LED lamp
- quiet operation
- lightweight 1,3 kg



LED lamp lighting of the cutting field

Cordless round knife with DC Servo motor

225 € NET



32 MM























- blade diameter 110 mm
- direct drive DC Servo motor
- 5-step speed regulation
- cutting height 32 mm
- LED lamp
- quiet operation
- lightweight 1,5 kg























LED lamp - 3-step work field lighting

Icons for *texi* sewing machines description

AUTO		THREAD TRIMMER
		BARTACKING AUTOMATIC
		WIPER
		AUTOMATIC PRESSER FOOT LIFTER
		AUTOMATIC NEEDLE POSITIONING
	BOTTOM FEED	
	NEEDLE FEED	
	COMPOUND FEED	
	UNISON FEED	
	DIFFERENTIAL BOTTOM FEED	
	BOTTOM ROLLER FEED AND ROLL PRESSER FOOT	

	NEEDLE SYSTEM
	TOTAL NEEDLE GAUGE
	SPLIT NEEDLES
	PRESSER FOOT LIFT HEIGHT
	LED LAMP
	TYPE OF SEWING MATERIAL
	SEWING SPEED
	BUILT-IN MOTOR
	NO. OF THRAEDS

	STITCH LENGTH
	
	
	
	
	STITCH WIDTH
	
	
	NO. OF PATTERNS
	

	BUTTONHOLE SIZE
	CLAMP SIZE
	KNIFE SIZE
	SYSTEM MULTI-CUT
	BARTACK SIZE
	BUTTON DIAMETER
	SEWING-IN POST BUTTON
	DISTANCE
	SKIP STITCH DEVICE
	POST HEIGHT
	POST CIRCUMFERENCE

texi 1-needle mechatronic lockstitch machines



Lockstitch machine with bottom feed



BOTTOM FEED



PRICE & INFO
www.strima.com/i4Tby

TEXI TRONIC 7 NF

Lockstitch machine with needle feed



PRICE & INFO
www.strima.com/i4Np5



NEEDLE FEED



TEXI TRONIC 1 NEO

Lockstitch machine with bottom feed



PRICE & INFO
www.strima.com/i4TdT



BOTTOM FEED

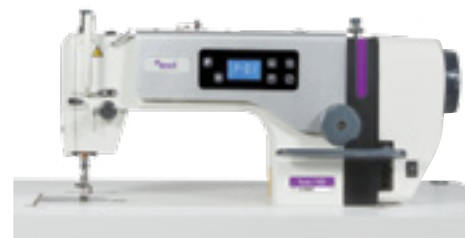

TEXI TRONIC 3 NEO

Lockstitch machine with bottom feed



PRICE & INFO
www.strima.com/i4UM1



BOTTOM FEED



AUTUMN PREMIERE

Sewing Machine	AUTO					Bottom Feed	Needle Feed	System	MM	MM	Stitch	Presser	Rotation	AC SERVO 230V
	Scissors	Reverse	Stitch	Presser	Stitch									
TEXI TRONIC 1 NEO	-	-	-	-	✓	✓	-	135x5	5	13	✓	L/M	5 000	550 W
TEXI TRONIC 3 NEO	✓	-	-	-	✓	✓	-	135x5	5	13	✓	L/M	5 000	550 W
TEXI TRONIC 6 NEO	✓	✓	-	✓	✓	✓	-	135x5	5	13	✓	L/M	5 000	550 W
TEXI TRONIC 7 NF	✓	✓	✓	✓	✓	-	✓	135x5	4.5	13	✓	L/M	4 000	550 W

texi 2-needle mechatronic lokstitch machines

TEXI TWIN MS

Two needle, lockstitch machine with needle feed and automatic needle positioning



PRICE & INFO
www.strima.com/i4N3U



NEEDLE FEED



TWO NEEDLES



AUTO												
-	-	-	-	PREMIUM EX	✓	135x5	6.4	✓	5	11	✓	L/M 3 000 550 W

PREMIUM	PREMIUM EX
<p>1 year warranty</p>	<p>2 years warranty</p>
<p>lower price</p>	<p>additional equipment</p>
	<p>EXTRAS & EXTENDED INDUSTRIAL WARRANTY</p>

texi Overlock (safety stitch) machines



TEXI QUATTRO 24 N

4-thread, mechatronic overlock machine



PRICE & INFO
www.strima.com/i4Tc0



TEXI TRE 04 N

3-threads mechatronic overlock machine



PRICE & INFO
www.strima.com/i4Tc4



TEXI CINQUE 35 N

5-thread, mechatronic overlock machine



PRICE & INFO
www.strima.com/i4Tc2



Sewing Machine	AUTO					Trim	Needle	System	MM	Collar	Sleeve	Cuff	Pocket	MM	Decorative	Fold	Roll	AC SERVO 230V
	Trim	Needle	System	MM	Collar													
TEXI TRE 04 N	-	-	-	-	✓	✓	1	B-27	-	3	4 mm	-	4 mm	6	✓	L/M	7 000	550 W
TEXI QUATTRO 24 N	-	-	-	-	✓	✓	2	B-27	2	4	6 mm	-	6 mm	6	✓	L/M	7 000	550 W
TEXI CINQUE 35 N	-	-	-	-	✓	✓	2	B-27	3	5	5 mm	8	5 mm	6	✓	L/M	7 000	550 W

texi Coverstitch (interlock) machines

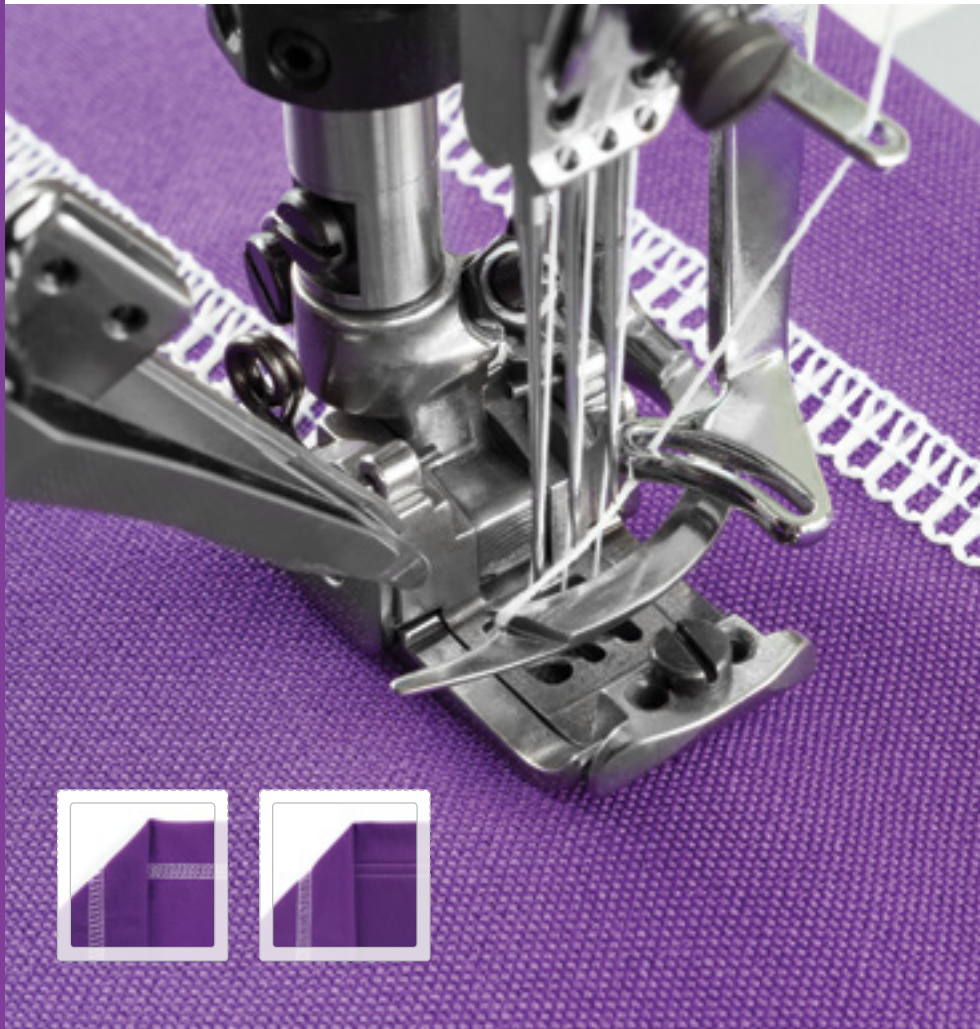

TEXI TRECCIA

3-needle flat-bed interlock machine



FLAT-BED



NEEDLE GAUGES
5.6 AND 6.4 MM
INCLUDED



TEXI TRECCIA C MATIC

3-needle cylinder-bed interlock machine



PRICE & INFO
www.strima.com/i4N3a



CYLINDER-BED



NEEDLE GAUGES
5.6 AND 6.4 MM
INCLUDED



	AUTO																
TEXI TRECCIA	-	-	-	-	✓	1:0.5 ~ 1:1.3	3	UY 128 GAS	5.6 / 6.4	5	1.6~4.2 mm	6	✓	-	6 000	550 W	
TEXI TRECCIA C MATIC	✓	-	✓	✓	✓	1:0.5 ~ 1:1.3	3	UY 128 GAS	5.6 / 6.4	5	1.6~4.2 mm	6	✓	✓	6 000	550 W	

texi. Specialized sewing machines

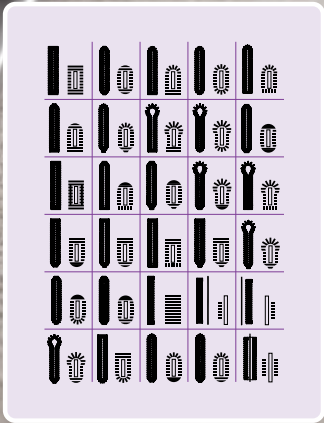

TEXI 781 SERVO

Buttonhole machine



PRICE & INFO
www.strima.com/i4MyU



AUTO						SYSTEM	A MM	B MM	MM	MM	MM	MM	MM	MM	MM	AC SERVO 230 V
✓	-	-	-	-	-	135x5	30 x 6	A = 6.4 - 25.4 B = 2.5 - 5	6.4 - 19.1	12	✓	L/M	3 600	550 W		
								A = 6.4 - 31.8 B = 2.5 - 5	6.4 - 31							

TEXI CATENACCIO 2.0

Electronic bartacking machine



PRICE & INFO
www.strima.com/i4Tbw

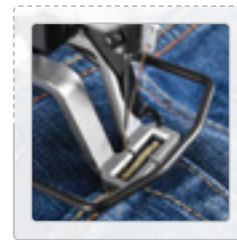

AUTO						SYSTEM	A MM	B MM	MM	MM	MM	MM	MM	MM	MM	AC SERVO 230 V
✓	-	✓	✓	-	-	135x5	A=20 B=4.5	A=18 B=4	15 (100)	16	✓	L/M/H	3 000	550 W		

TEXI O

Electronic buttonhole machine



PRICE & INFO
www.strima.com/i4N3c



AUTO						SYSTEM	PATTERNS	A MM	B MM	MM	MM	MM	MM	MM	MM	AC SERVO 230 V
✓	-	-	✓	-	-	135x5	30	A = 9.4 - 38.0 B = 6.4 - 31.8	A = 29, B = 5 A = 40, B = 6	✓	14	✓	L/M	3 600	550 W	

TEXI X

Electronic button sewing machine



PRICE & INFO
www.strima.com/i4N3d

827 € NET

PATTERNS IN CYCLE



8, 16, 32

TEXI ZIGGY

Electronic zigzag machine with automatic functions



PRICE & INFO
www.strima.com/i4N3b

BASIC



AUTO

✓	-	-	✓	-	TQX1/TQX7	12	∅=10~28	A: 2.5 - 6.5	volba	1500	550 W

AUTO

✓	✓	✓	✓	✓	135x5	29	114	5.0	10.0	6	✓	L/M	5000	550 W

TEXI ACCURA

Blind stitch machine for light and medium materials



PRICE & INFO
www.strima.com/i4N3g

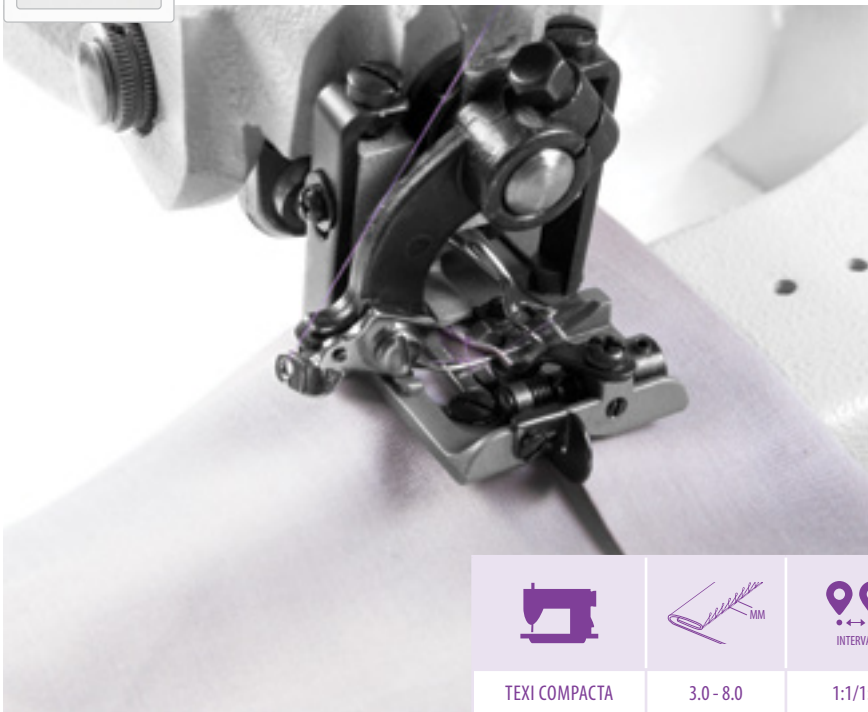

TEXI COMPACTA

Portable blind stitch machine for light and medium fabrics



PRICE & INFO
www.strima.com/i4N3f



195 € NET



TEXI COMPACTA	3.0 - 8.0	1:1/1:2	2140 TP	1 200	90 W
TEXI ACCURA	3.0 - 8.0	1:1/1:2	2140 TP	2 500	550 W



PORTABLE

texi TRONIC 3 NEO

NEW!

★ ★ ★
GREAT PRICE
★ ★ ★

QR CODE
PRICE & INFO
www.strima.com/i4UM1



AUTO

Automatic thread cutting

Tronic 3 NEO
851A0001

INDUSTRIAL SEWING MACHINES

texi Walker series

Upholstery and leather lockstitch machines



TEXI WALKER WF AUT

Automatic lockstitch machine



PRICE & INFO
www.strima.com/14S1o



TEXI WALKER WF SERVO

Lockstitch machine



PRICE & INFO
www.strima.com/14S1q



	AUTO														
TEXI WALKER WF SERVO	-	-	-	-	✓	✓		135x17	8	33,5	16	✓	M/H	2 000	550 W
TEXI WALKER WF AUT	✓	✓	-	✓	✓	✓		135x17	8	33,5	16	✓	M/H	2 000	550 W

texi HD series

Upholstery and leather lockstitch machines

TEXI HD FORTE UF

Lockstitch machine with unison feed



PRICE & INFO
www.strima.com/i4N3Q

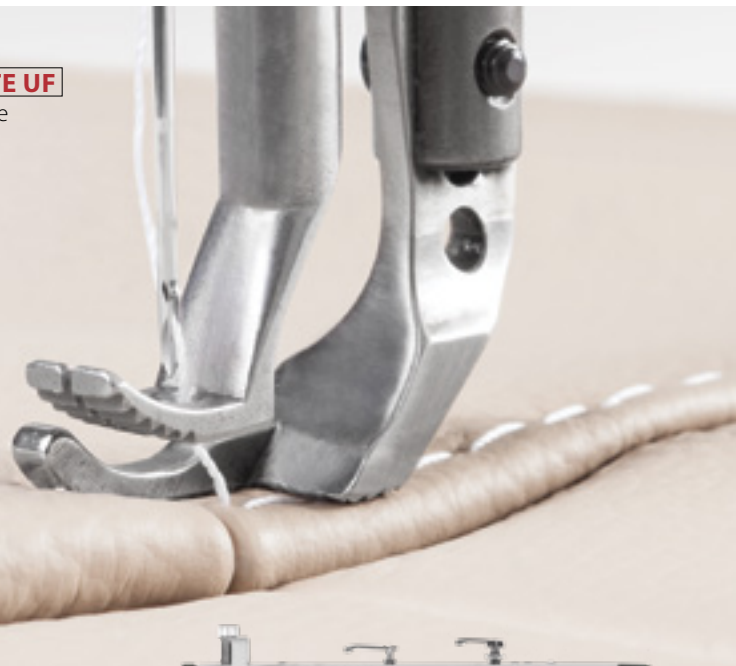

TEXI HD FORTE-B UF

Lockstitch binding machine



PRICE & INFO
www.strima.com/i4Nkf



TEXI HD FORTE CILINDRO UF

Lockstitch cylinder-bed machine



PRICE & INFO
www.strima.com/i4N3R











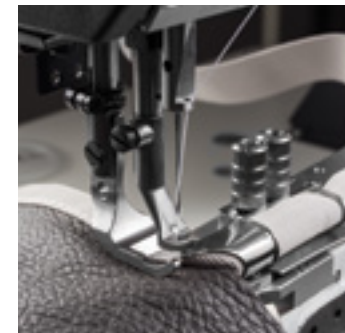







TEXI HD FORTE CILINDRO-B UF

Lockstitch cylinder-bed binding machine



PRICE & INFO
www.strima.com/i4N3S



	AUTO							 SYSTEM	 CM	 MM	 MM	 AC SERVO 230 V	 CYLINDER-BED	 BINDING	
															
TEXI HD FORTE UF	-	-	-	-	PREMIUM EX	✓		134 - 35	26	8	14	2 800	750 W	-	-
TEXI HD FORTE-B UF	-	-	-	-	PREMIUM EX	✓		134 - 35	26	8	14	2 800	750 W	-	✓
TEXI HD FORTE CILINDRO UF	-	-	-	-	PREMIUM EX	✓		134 - 35	26	6	14	2 800	750 W	✓	-
TEXI HD FORTE CILINDRO-B UF	-	-	-	-	PREMIUM EX	✓		134 - 35	26	6	14	2 800	750 W	✓	✓

TEXI POST DD PREMIUM

Post-bed lockstitch machine with bottom, needle and upper roller feed



PRICE & INFO
www.strima.com/i4NxX



TEXI SEP SYSTEM

Multifunctional machine for sewing, embroidering and perforating leather and coated fabrics



PRICE & INFO
www.strima.com/i4Twd

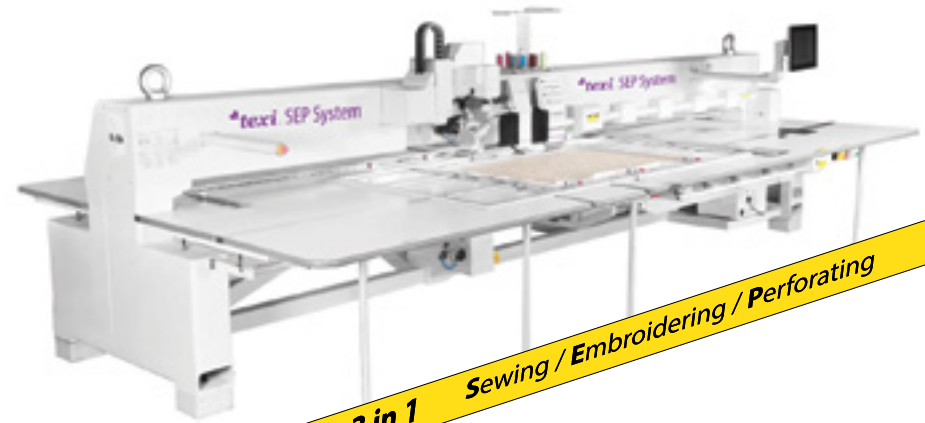

3 in 1 Sewing / Embroidering / Perforating

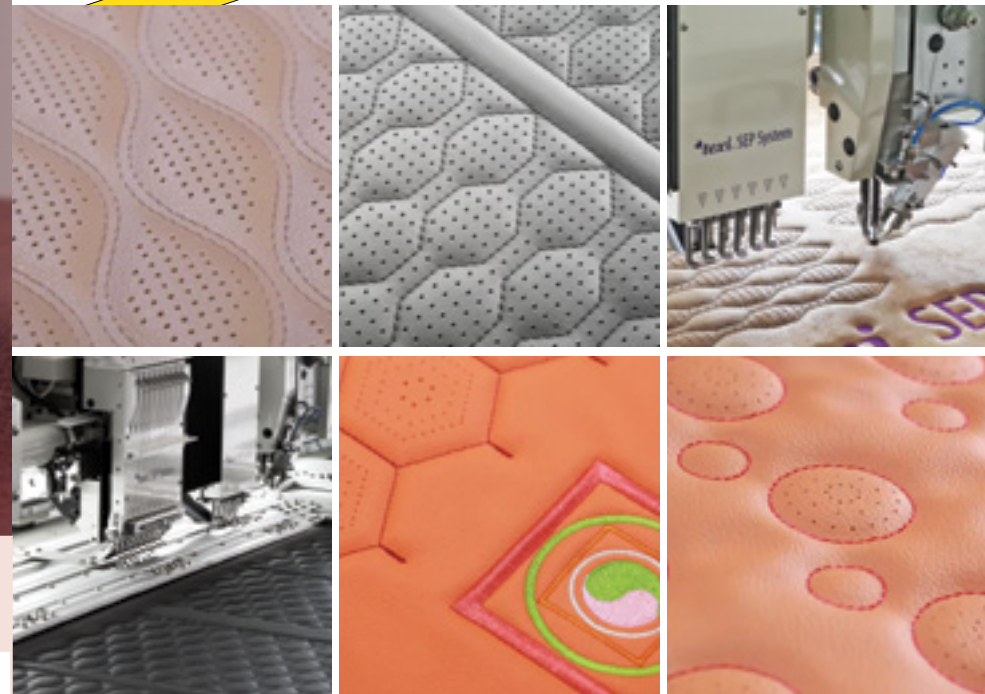

AUTO											
✓	✓	-	-	✓	✓	135x5	17	21	4.5	8	✓
									M/H	3 000	750 W

texi Heat presses

TEXI HP-0408FC

Press for printing on caps



PRICE & INFO
www.strima.com/i4Tm9

TEXI HP-1112HM

Press for printing on mugs



PRICE & INFO
www.strima.com/i4TmA

TEXI HP-1620F-T

Flat press for printing



PRICE & INFO
www.strima.com/i4Tm7



✉ sales@strima.com

texi Embroidery machines

TEXI 1501 TS PREMIUM

One-head, fifteen-needle industrial embroidery machine



PRICE & INFO
www.strima.com/i4NxV

1

Head

15

Needles

1 200

Maximum speed (stitches per minute)



Memory capacity: 20 million stitches or 200 designs



High-Definition True-Color 7" LCD touch screen



500 x 360 mm (19.7 x 14.2 in)

13

Hoops



2 cap rings, cap driver, hoop station



Caps, flats & more



TEXI IRIS 10

Compact, 10-needle embroidery machine



PRICE & INFO
www.strima.com/i40Jc

1

Head

10

Needles

1 000

Maximum speed (stitches per minute)



Memory capacity: 20 million stitches or 200 designs



High-Definition True-Color 7" LCD touch screen



310 x 210 mm (12.2 x 8.3 in)

4

Hoops



Cap ring, cap driver, hoop station



Caps, flats & more



PORTABLE

www.strima.com



TEXI 4003

Pin for quick foot fixing



PRICE & INFO
www.strima.com/i4LaY



TEXI 3 FEET

Turret for 3 presser feet for lockstitch machine



PRICE & INFO
www.strima.com/i4TmZ

23.31 € NET

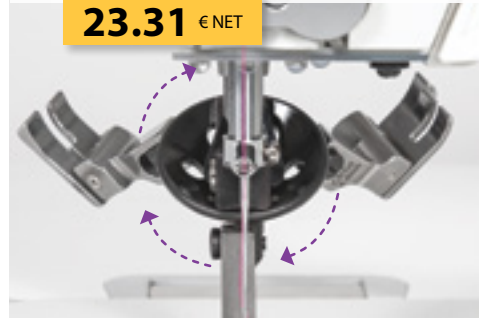

TEXI 5001

Foot for sewing leather and other difficult materials



PRICE & INFO
www.strima.com/i4Lb4

TEXI 4026

Thread cutter



PRICE & INFO
www.strima.com/i4Law

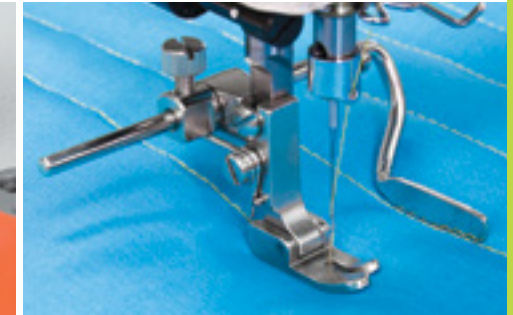

TEXI 5003

Foot with left and right gauges



PRICE & INFO
www.strima.com/i4Lb6



TEXI 5004

PTFE foot with rings



PRICE & INFO
www.strima.com/i4Lb7



TEXI 5006

Double hemming foot 1/8" (3.2 mm)



PRICE & INFO
www.strima.com/i4Lb9



TEXI 5007

Single hemming foot
1/8" (3.2 mm)



PRICE & INFO
www.strima.com/i4LbB



TEXI 5010

Adjustable
shirring foot



PRICE & INFO
www.strima.com/i4LbE



TEXI 5013

Standard foot



PRICE & INFO
www.strima.com/i4LbH



TEXI 5014

Roller foot
for difficult fabrics



PRICE & INFO
www.strima.com/i4LbI



Cording foot, narrow

TEXI 5008

Left



PRICE & INFO
www.strima.com/i4LbC

TEXI 5009

Right



PRICE & INFO
www.strima.com/i4LbD

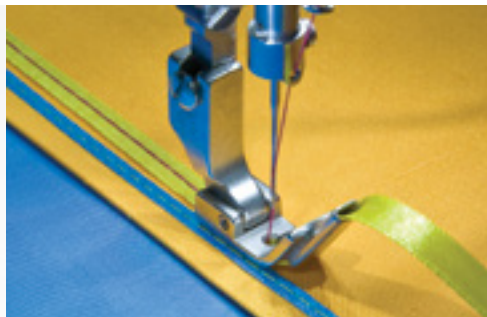

TEXI 5015

Foot with central tape
guide 4.8 mm



PRICE & INFO
www.strima.com/i4LbJ



TEXI 5020

Piping foot
3.2 mm, left



PRICE & INFO
www.strima.com/i4LbO



TEXI 5011

Zipper foot



PRICE & INFO
www.strima.com/i4LbF

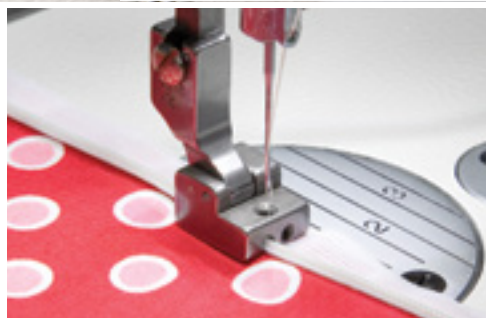

TEXI 5012

Invisible zipper
foot



PRICE & INFO
www.strima.com/i4LbG



Compensating foot 1.0 mm

TEXI 5016

Right



PRICE & INFO
www.strima.com/i4LbK

TEXI 5017

Left



PRICE & INFO
www.strima.com/i4LbL



Compensting PTFE coated foot, 1.0 mm

TEXI 5018

Right



PRICE & INFO
www.strima.com/i4LbM

TEXI 5019

Left



PRICE & INFO
www.strima.com/i4LbN



TEXI 6002

Tape binder
5/8" (16/8 mm)



PRICE & INFO
www.strima.com/i4LBR

7,95 mm



TEXI 6003

Swing hemmer
3/8" (9.53 mm)



PRICE & INFO
www.strima.com/i4LbS

9,53 mm



TEXI 5021

Foot for hemmer



PRICE & INFO
www.strima.com/i4LbP



TEXI 5022

Foot for fine fabrics



PRICE & INFO
www.strima.com/i4LdR



TEXI 4004

Universal screw for binders, hemmers and gauges (2 pcs)



PRICE & INFO
www.strima.com/i4LaZ



TEXI 4009

Magnetic gauge



PRICE & INFO
www.strima.com/i4Laf



TEXI 5023

Foot for heavy fabrics



PRICE & INFO
www.strima.com/i4LdS



TEXI 6001

Right angle bias binder
30/8 mm



PRICE & INFO
www.strima.com/i4LbQ

8 mm

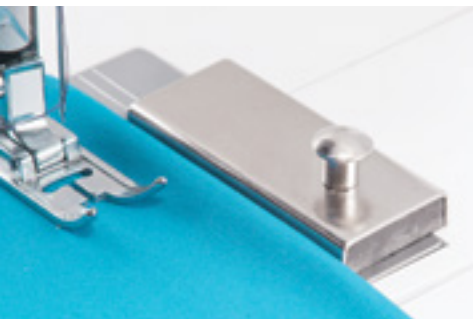

TEXI 4010

Magnetic gauge - long (50 mm) and very strong



PRICE & INFO
www.strima.com/i4Lag



TEXI 4021

Sewing gauge



PRICE & INFO
www.strima.com/i4Lar

texi Needles for industrial sewing machines

Point types for knitted and woven fabrics

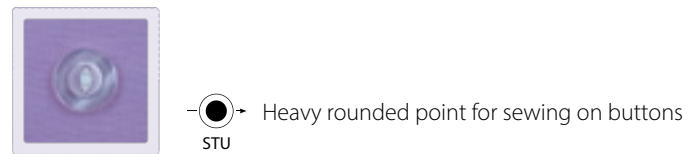
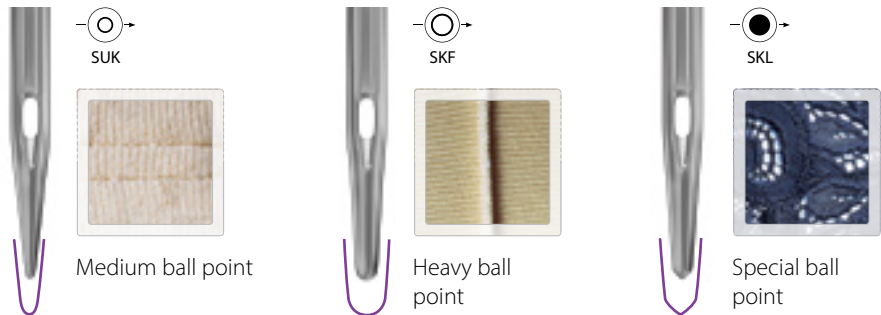
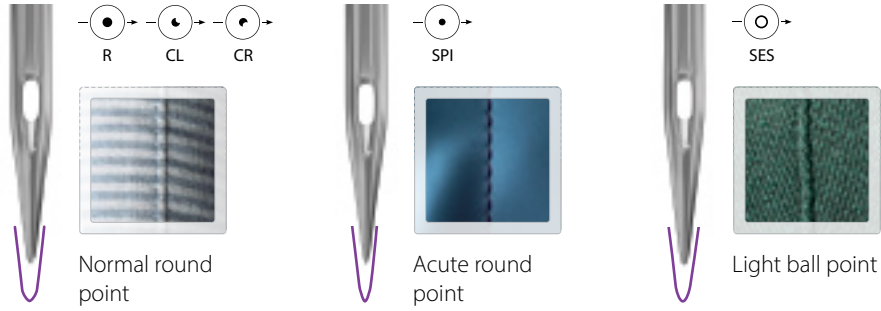

PRICE & INFO
www.strima.com/s1015

sales@strima.com

Point types (blades) for leather

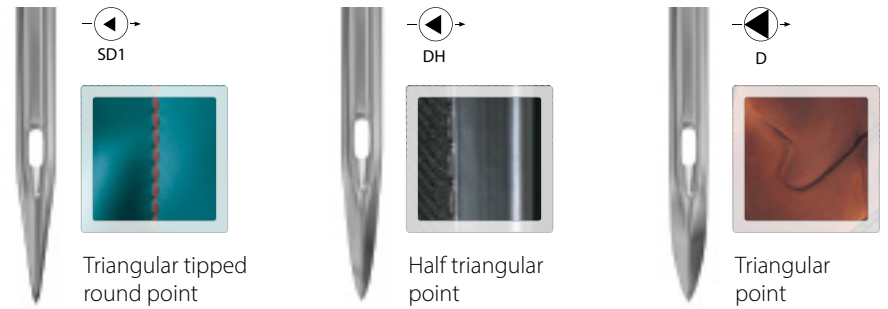
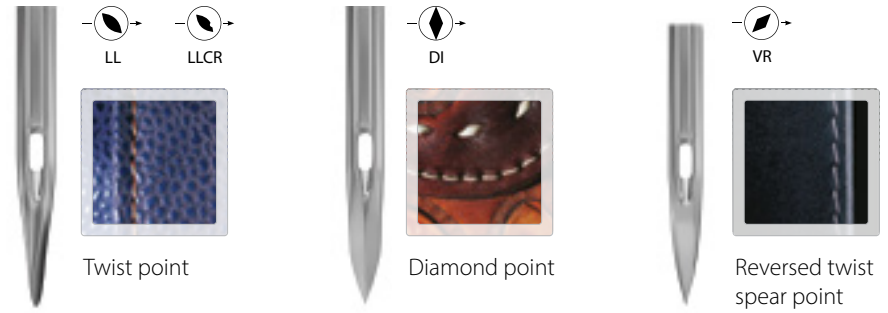
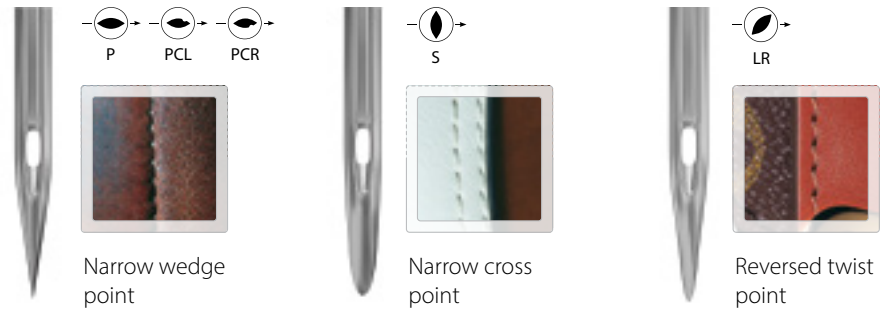

www.strima.com

texi. Needles for household sewing machines



EASY WITH COLOR

NEEDLE TYPE



- 60
- 65
- 70
- 75
- 80
- 90
- 100
- 110
- 120
- 125
- 130



NEEDLE SIZE IN MM



NEEDLES FOR HOUSEHOLD SEWING MACHINES

TEXI JEANS

Jeans needle for tightly woven fabrics.



PRICE & INFO
www.strima.com/s1004

-  JEANS 130/705 H-J 5x70
-  JEANS 130/705 H-J 5x80
-  JEANS 130/705 H-J 5x90
-  JEANS 130/705 H-J 5x100
-  JEANS 130/705 H-J 5x110
-  JEANS 130/705 H-J 2x90, 2x100, 1x110









TEXI LEATHER

Leather needle with cutting point for leather, imitation leather and similar materials. Not suitable for textiles.



PRICE & INFO
www.strima.com/s1005

-  LEATHER 130/705 H LL 5x70
-  LEATHER 130/705 H LL 5x80
-  LEATHER 130/705 H LL 5x90
-  LEATHER 130/705 H LL 5x100
-  LEATHER 130/705 H LL 5x110
-  LEATHER 130/705 H LL 5x120
-  LEATHER 130/705 H LL 2x80, 2x90, 1x100

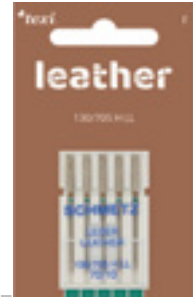





TEXI MICROTEx

Microtex needle for silk, microfibre fabrics, coated fabrics and foils.



PRICE & INFO
www.strima.com/s1006

-  MICROTEx 130/705 H-M 5x60
-  MICROTEx 130/705 H-M 5x70
-  MICROTEx 130/705 H-M 5x80
-  MICROTEx 130/705 H-M 5x90
-  MICROTEx 130/705 H-M 2x60, 2x70, 1x80





TEXI QUILTING

Special needle for quilting and patchwork.



PRICE & INFO
www.strima.com/s1007

-  QUILTING 130/705 H-Q 5x75
-  QUILTING 130/705 H-Q 5x90
-  QUILTING 130/705 H-Q 3x75, 2x90

















TEXI UNIVERSAL

Universal needle for most fabrics, also Jersey, synthetics etc.



PRICE & INFO
www.strima.com/s1001

-  UNIVERSAL 130/705 H 5x60
-  UNIVERSAL 130/705 H 5x70
-  UNIVERSAL 130/705 H 5x80
-  UNIVERSAL 130/705 H 5x90
-  UNIVERSAL 130/705 H 5x100
-  UNIVERSAL 130/705 H 5x110
-  UNIVERSAL 130/705 H 5x120
-  UNIVERSAL 130/705 H 2x70, 2x80, 1x90
-  UNIVERSAL 130/705 H 1x70, 2x80, 1x90, 1x100
-  UNIVERSAL 130/705 H 10x70
-  UNIVERSAL 130/705 H 10x80
-  UNIVERSAL 130/705 H 10x90
-  UNIVERSAL 130/705 H 10x100
-  UNIVERSAL 130/705 H 2x70, 3x80, 3x90, 2x100
-  UNIVERSAL 130/705 H 10x60-110



TEXI STRETCH

Stretch needle for elastic materials and highly elastic knitwear.



PRICE & INFO
www.strima.com/s1002

-  STRETCH 130/705 H-S 5x65
-  STRETCH 130/705 H-S 5x75
-  STRETCH 130/705 H-S 5x90
-  STRETCH 130/705 H-S 3x75, 2x90







TEXI JERSEY

Ball point needles (medium ball) for household machines.



PRICE & INFO
www.strima.com/s1003

-  JERSEY 130/705 H SUK 5x70
-  JERSEY 130/705 H SUK 5x80
-  JERSEY 130/705 H SUK 5x90
-  JERSEY 130/705 H SUK 5x100
-  JERSEY 130/705 H SUK 2x70, 2x80, 1x90





TEXI EMBROIDERY

Special needle for embroidering with voluminous threads and woollen threads.



PRICE & INFO

www.strima.com/s1008

-  EMBROIDERY 130/705 H-E 5x75
-  EMBROIDERY 130/705 H-E 5x90
-  EMBROIDERY 130/705 H-E 3x75, 2x90

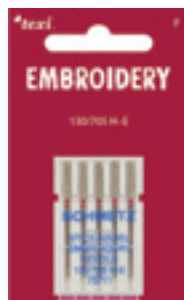

TEXI COVERLOCK OVERLOCK

Needle for overlock and coverlock machine.



PRICE & INFO

www.strima.com/s1012

-  OVERLOCK/COVERLOCK ELX705 5x80
-  OVERLOCK/COVERLOCK ELX705 5x90
-  OVERLOCK/COVERLOCK ELX705 CF 5x65
-  OVERLOCK/COVERLOCK ELX705 CF 5x80
-  OVERLOCK/COVERLOCK ELX705 CF 5x90
-  OVERLOCK/COVERLOCK ELX705 SUK CF 5x65
-  OVERLOCK/COVERLOCK ELX705 SUK CF 5x80
-  OVERLOCK/COVERLOCK ELX705 SUK CF 5x90

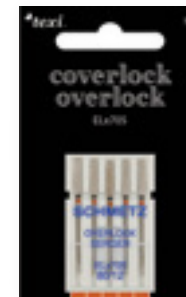

TEXI METALLIC

Metallic needle for trouble free sewing with sensitive metallic decorative threads.



PRICE & INFO

www.strima.com/s1009

-  METALLIC 130 MET 5x80
-  METALLIC 130 MET 5x90



TEXI DOUBLE EYE

Double eye needle for topstitching with decorative threads.



PRICE & INFO

www.strima.com/s1010

-  DOUBLE EYE 705 DE 5x80









TEXI UNIVERSAL TWIN

Twin needle for decorative stitch.
Only for use on zig-zag-machines with transversal hook.



PRICE & INFO

www.strima.com/s1011

-  UNIVERSAL TWIN 130/705 H ZWI NE 2,0-80
-  UNIVERSAL TWIN 130/705 H ZWI NE 2,5-80
-  UNIVERSAL TWIN 130/705 H ZWI NE 3,0-90
-  UNIVERSAL TWIN 130/705 H ZWI NE 4,0-80
-  UNIVERSAL TWIN 130/705 H ZWI NE 4,0-90
-  UNIVERSAL TWIN 130/705 H ZWI BR NE 6-100
-  UNIVERSAL TWIN 130/705 H ZWI BR NE 8-100



TEXI CREATIVE 5

Needles for household machines MIX, 5 pcs



PRICE & INFO

www.strima.com/i4RAK

TEXI CREATIVE 9+

Needles for household machines MIX, 9 pcs



PRICE & INFO

www.strima.com/i4RAI

TEXI CREATIVE 10

Needles for household machines MIX, 10 pcs



PRICE & INFO

www.strima.com/i4TIW



texi Household sewing machines

TEXI JOY 13

Automatic multifunctional sewing machine, 13 stitches



PRICE & INFO
www.strima.com/s1013



enjoy
YOUR COLOR!



Main functions:

- 13 built-in stitches (including straight, zig-zag and decorative stitches)
- 4-step buttonhole
- Regulation of stitch length (max 3,6 mm) and width (max 4 mm)
- Backward sewing
- Maximum sewing speed 650 s.p.m
- Snap-on feet – SYSTEMATIC
- Easy threading
- Free arm for circular sewing
- LED lamp
- Thread cutter
- Shuttle hook

Equipped with:

standard foot, buttonhole foot, 2 bobbins, needle set, seam ripper, spool pin cap, oiler, soft cover



Free arm for circular sewing

3 years warranty

safe for a child

the best to start

13 STITCHES



OPTION

TEXI JOY 13 EXTENSION TABLE

Table dimensions: 22,5 cm x 32 cm



PRICE & INFO
www.strima.com/i400T



www.strima.com

EXTRAS INSIDE!



TEXI FOX 25

Automatic multifunctional sewing machine, 25 stitches



PRICE & INFO
www.strima.com/i4SZU



3 years warranty

Equipped with:

standard foot, zipper foot, buttonhole foot, presser foot for sewing buttons, hem guide, 3 bobbins, needle set, seam ripper/brush, multi-function screwdriver, foot controller, oiler, soft cover.

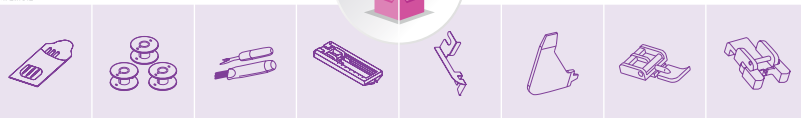

✉ sales@strima.com

Main functions:

- 25 built-in stitches (including straight, zig-zag and decorative)
- 4-step buttonhole
- Regulation of stitch length (max. 4 mm) and width of zig-zag stitch type (max. 4 mm)
- Presser foot height 5,5 mm
- Backwards sewing
- Maximum sewing speed 700 s.p.m.
- Snap-on feet - SYSTEM MATIC
- Free arm for circular sewing
- LED lamp
- Thread cutter
- Shuttle hook
- Needle threader

25 STITCHES

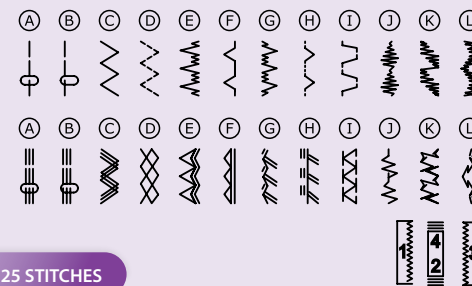

Contains a set of snap-on feet SYSTEM MATIC

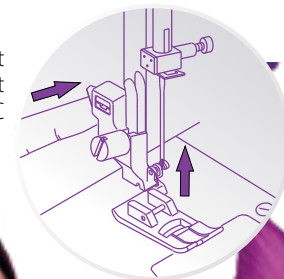

REMEMBER ABOUT:

TEXI FOX 25 EXTENSION TABLE

Table enlarging the working area, dimensions: 36 cm x 26 cm.



PRICE & INFO
www.strima.com/i4Sfs



TEXI JOY 48

Multifunctional mechanical sewing machine, 48 stitches

155 € NET



PRICE & INFO
www.strima.com/i40W6

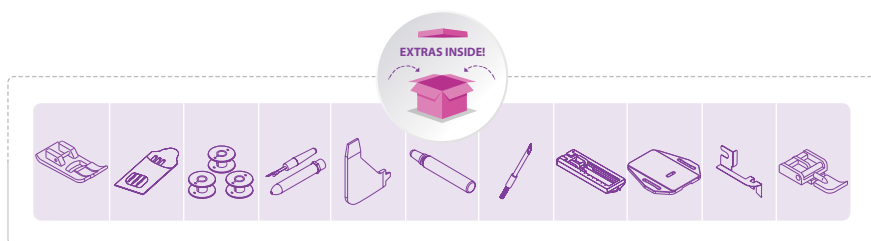

Main functions:

- 48 built-in stitches (including straight, zig-zag and decorative)
- 4-step buttonhole
- Regulation of stitch length (max 4 mm) and width (max 5 mm)
- Electronic stitch selection and regulation of stitch width
- Needle positioning button
- Presserfoot height 5,5 mm
- Backwards sewing
- Maximum sewing speed 700 s.p.m
- Snap-on feet – SYSTEM MATIC
- Free arm for circular sewing
- Lamp (LED)
- Thread cutter
- Shuttle hook

Equipped with:

standard foot, zipper foot, buttonhole foot, embroidery plate, hem guide, 3 bobbins, needle set, seam ripper, brush, screwdriver, foot controller, oiler, soft cover

Free arm for circular sewing

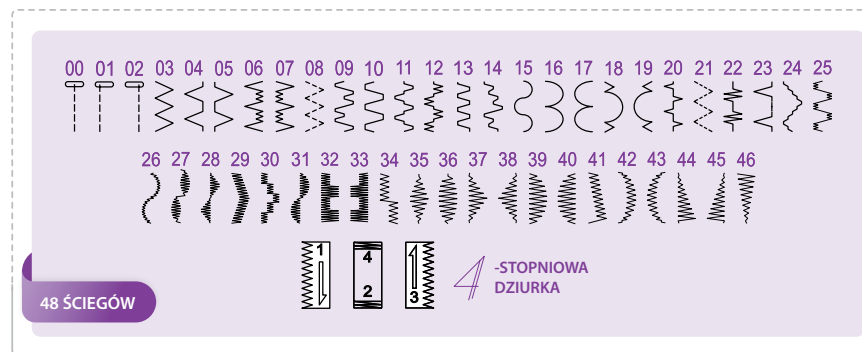
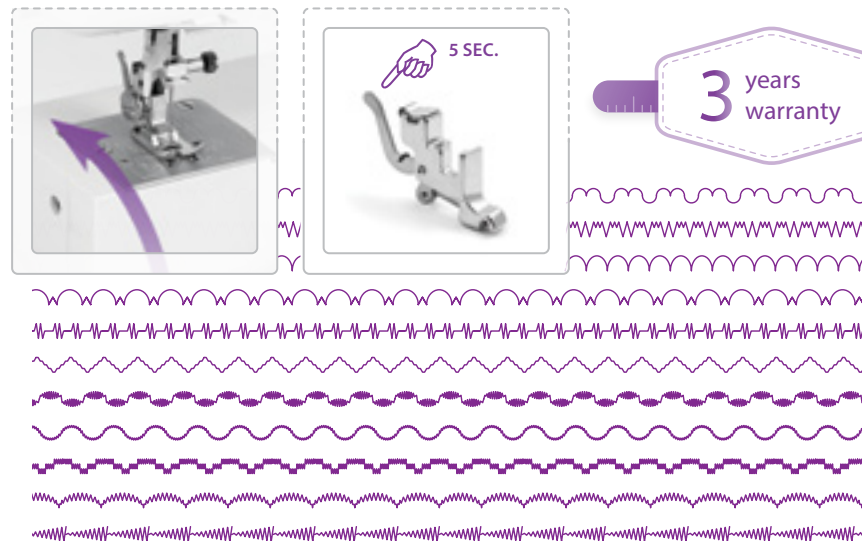

TEXI BLACK&WHITE

Multifunctional, computerized sewing machine

238 € NET



PRICE & INFO
www.strima.com/i4Rfl



3 years warranty

the best extras as standard

200 programs

Equipped with:

set of needles, double needle, bobbins, ripper/ Brush, screwdriver for needle plate, spool pin cap, small screwdriver, auxiliary spool pin, satin stitch foot, zipper foot, blind stitch foot, button foot, buttonhole foot, foot controller.



WYPOSAZENIE MASZYNY



Main functions:

- 200 Sewing programs (including 9 types of buttonhole, straight, zig-zag, overlock and decorative stitches)
- Alphabet font
- Smooth regulation of stitch length (max. 4.5 Mm) and width (max. 7 mm)
- Backwards sewing
- Double needle sewing
- Maximum sewing speed 750 s.p.m.
- Electronic sewing speed regulation
- Lcd control panel
- Start/stop button
- Slow start button
- Needle positioning (top/bottom)
- Needle threader
- Snap-on feet - matic system
- Free arm for circular sewing
- Led lamp
- Rotary hook
- Metal componenets
- Drop feed lever



free arm for circular sewing

OPTION

TEXI BLACK&WHITE EXTENSION TABLE

Table dimensions: 42 cm x 29 cm



PRICE & INFO
www.strima.com/i4Rt0

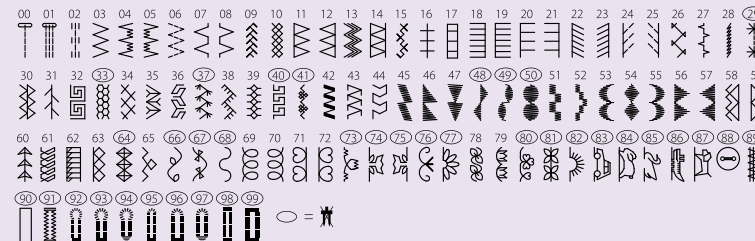

00 01 02 03 04 05 06 07 08 09 10 11 12 13 14 15 16 17 18 19 20 21 22 23 24 25 26 27 28 29
 0 1 2 3 4 5 6 7 8 9 A B C D E F G H I J K L M N O P Q R S T U V W X Y Z a b c d e f
 g h i j k l m n o p q r s t u v w x y z @ ! ? & # \$ % ' " , . - / : ; A A E a a e e
 84 85 86 87 88 89 90 91 92 93 94 95 96 97 98 99
 ê ë ç œ ã | ñ ò ó ô õ ö ù ü

200 STITCHES

TEXI BALLERINA SET

Computerized sewing machine, 200 stitch programs



PRICE & INFO
www.strima.com/14Rx5

447 € NET

Main functions:

- 200 stitch programs including alphabet font
- Smooth regulation of stitch length (max 5 mm) and width (max 7 mm)
- Backwards sewing
- Maximum sewing speed 750 s.p.m
- Electronic sewing speed regulation
- Buttons: pattern clear/erase function (CL), pattern memory function (ME), mirror stitches (MI), pattern repeating (RE), Start/Stop, Slow Start
- Needle positioning (top/bottom)
- Sewing "stitch by stitch"
- Adjustable presser foot pressure
- Drop feed lever
- Snap-on feet - MATIC SYSTEM
- Free arm for circular sewing

Equipped with:

extension table, LED lamp, thread cutter, needle threader, seam ripper with brush, 4 bobbins, spool pin cap (small and big), set of screwdrivers, set of feet

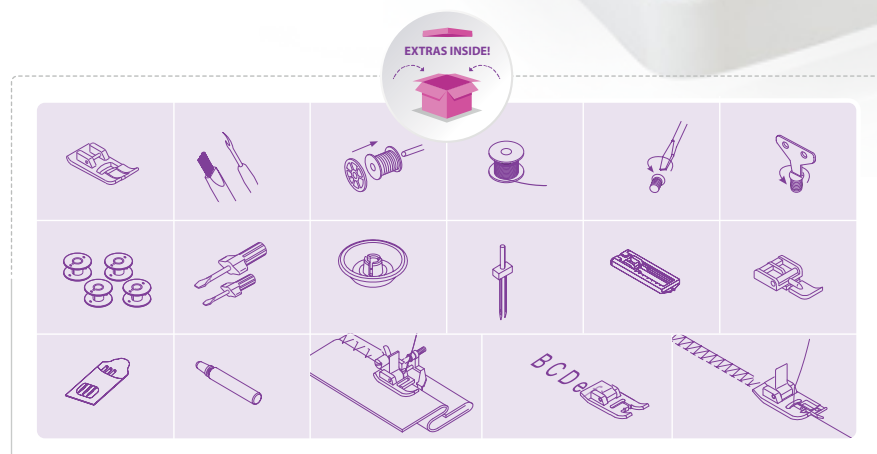

3 years warranty

the best extras as standard

200 programs

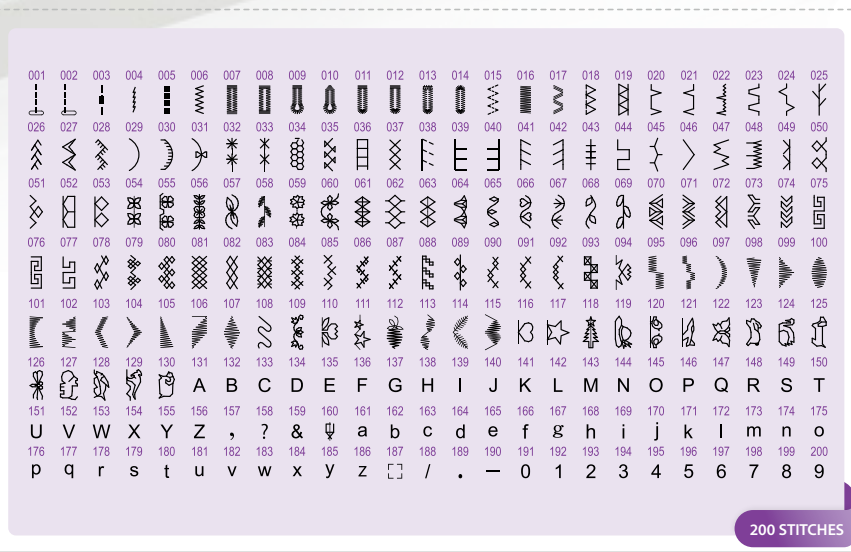

Become a ballerina with Texi Ballerina



TEXI BALLERINA



DOWNLOAD TUTORIAL
AND SEW PETTISKIRT WITH US.

www.strima.com/i4Rx5

✉ sales@strima.com

REMEMBER ABOUT:

TEXI ENJOY SEWING MACHINE BAG

Bag for household sewing machine



PRICE & INFO
www.strima.com/i4NzY

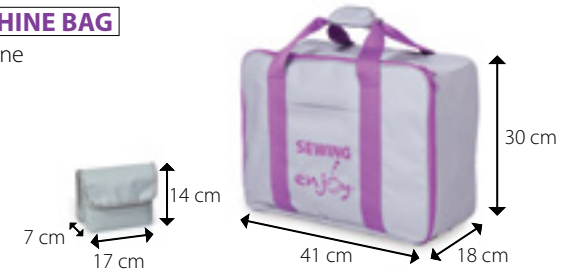

TEXI ENJOY MAXI SEWING MACHINE BAG

Bag for household sewing machine, large



TEXI ENJOY OVERLOCK BAG

Bag for household overlock machine



PRICE & INFO
www.strima.com/i4NzZ



TEXI ENJOY MAXI OVERLOCK BAG

Bag for household overlock machine, large



PRICE & INFO
www.strima.com/i4Ti5



www.strima.com

TEXI JOYLOCK

2, 3, 4-thread overlock machine for all types of materials

198 € NET



PRICE & INFO
www.strima.com/i4NxQ



Main functions:

- 7 basic types of overlock stitches including rolled hem
- Differential feed ratio 0.7 – 2.0 mm
- Maximum sewing speed 1200 s.p.m.
- Stitch length 1 – 5 mm
- Stitch width up to 6 mm
- Presser foot lift up to 6 mm
- Adjustable presser foot pressure
- Mechanical integrated thread cutter ①
- Protection against machine start when looper threading
- Waste container ②
- Adjustable cutting width
- Deactivatable upper knife
- Color-coded threading system

Equipped with:

lamp, 4 x spool pin cap, 4 x thread net, 4 x spool holder, tweezers, screwdriver x2, spanner, cleaning brush, machine oil, needle set, stitch finger, 2- thread converter, moving cutter, foot controller, soft cover, accessory bag

3 years warranty

you'll love it



REMEMBER ABOUT:

TEXI 4079

A cleaning kit for each sewing machine



CENA I INFO
www.strima.com/i4SE3

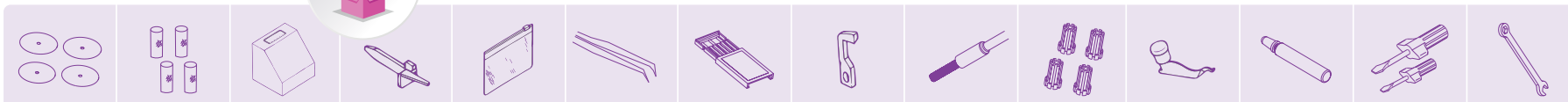



TEXI 1050
5 feet set
for Texi overlocks



PRICE & INFO
www.strima.com/i4MIQ



EASY TO THREAD

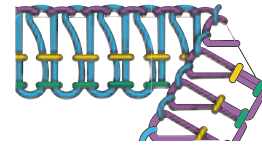

- Lower looper
- Upper looper
- Right needle
- Left needle

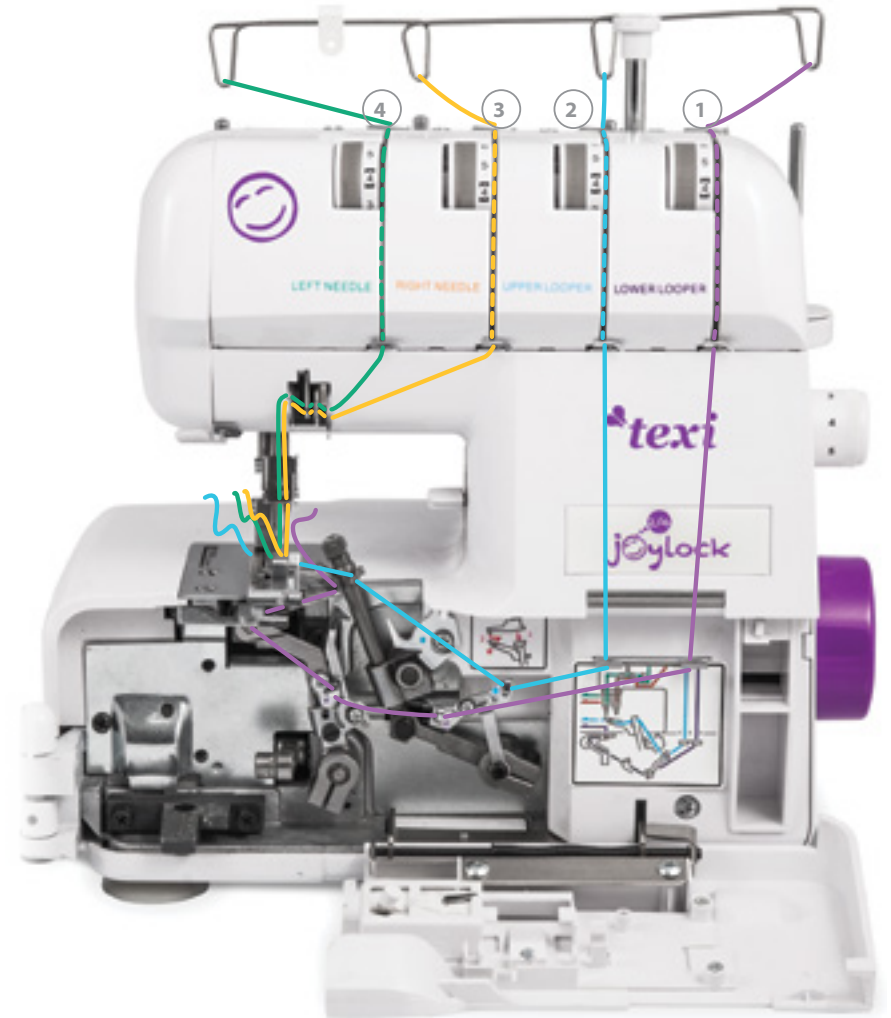

4-thread, safety stitch



3-thread, wide

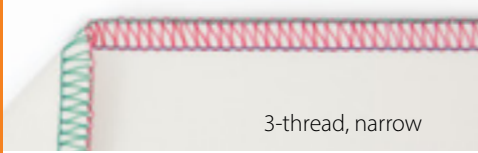

3-thread, narrow



Rolled hem



Decorative overedge



2-thread overedge

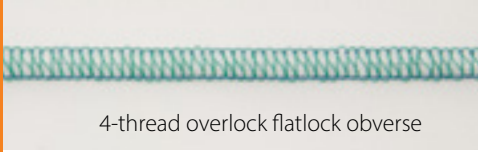

4-thread overlock flatlock obverse



4-thread overlock flatlock reverse

TEXI TEGRA

2, 3, 4-thread overlock machine for all types of materials

219 € NET



PRICE & INFO
www.strima.com/i4SZV

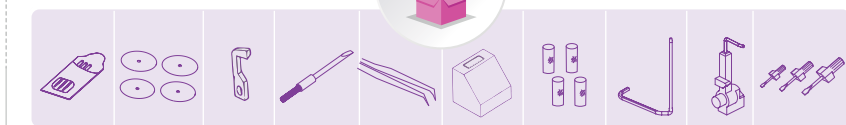

Main functions:

- Number of threads: 2, 3 or 4 threads
- Overedge stitch width: 6,7 mm
- Needle: HA1-SP
- HA x1(130/705H) / 12 / 80
- Stitch length: 1-4 mm
- Stitching speed: up to 1200 stitches per minute
- Presser foot lift: up to 4 mm
- Differential feed ratio: 0.7 – 2.0
- Dimensions: 360 mm (s) x 380 mm (g) x 380 mm (w)
- Weight 9,2 kg
- Adjustable presser foot pressure
- Manual thread cutter
- Waste container
- Protection against machine start when looper threading
- Adjustable cutting width
- Deactivatable upper knife
- Color-coded threading system
- LED lamp
- Tension release mechanism for easy thread pulling
- Free arm for circular sewing

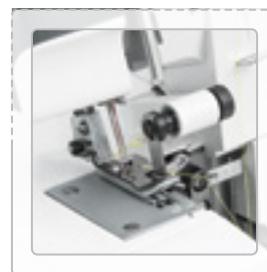

Free arm for circular sewing

Equipped with:

needles - 3 pcs, spool disc, lower knife, guide bar, brush, tweezers, screwdriver (s), screwdriver (m), screwdriver (l), two-thread convertor.

3 years warranty

13 STITCHES

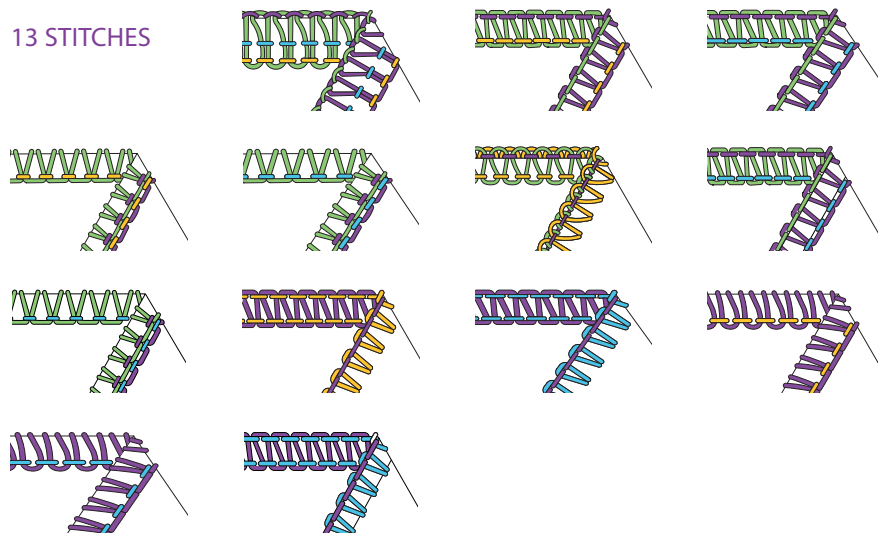

texi Folding cabinet – tailor's workshop

TEXI SESAME DUO

Folding cabinet for 2 sewing machines

CHOOSE YOUR COLOR



texi Accessories for household sewing machines

TEXI 0008

Invisible zipper foot, high fastening type



PRICE & INFO
www.strima.com/i4LZJ



TEXI 0009

Embroidery foot



PRICE & INFO
www.strima.com/i4LZI



TEXI 0014

Foot for piecing together two materials close to their edge



PRICE & INFO
www.strima.com/i4LZN



TEXI 0019

Double-sided, wide, zipper and cording foot



PRICE & INFO
www.strima.com/i4LZS



TEXI 0010

Sewing and shirring foot



PRICE & INFO
www.strima.com/i4LZJ

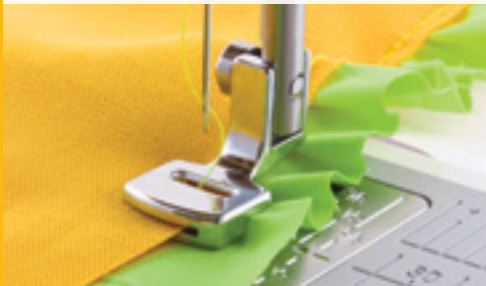

TEXI 0011

Shirring foot



PRICE & INFO
www.strima.com/i4LZK



Double-sided, narrow zipper foot for household machine

TEXI 0017

Low fastening type



PRICE & INFO
www.strima.com/i4LZQ



TEXI 0018

High fastening type



PRICE & INFO
www.strima.com/i4LZR

TEXI 0022

Ruffler



PRICE & INFO
www.strima.com/i4LZW



TEXI 0023

Flower stitch foot



PRICE & INFO
www.strima.com/i4LZW



TEXI 0012

Application foot



PRICE & INFO
www.strima.com/i4LZL



TEXI 0013

Roller foot for difficult fabrics



PRICE & INFO
www.strima.com/i4LZM





TEXI 0024
Even feed foot



PRICE & INFO
www.strima.com/i4LZX

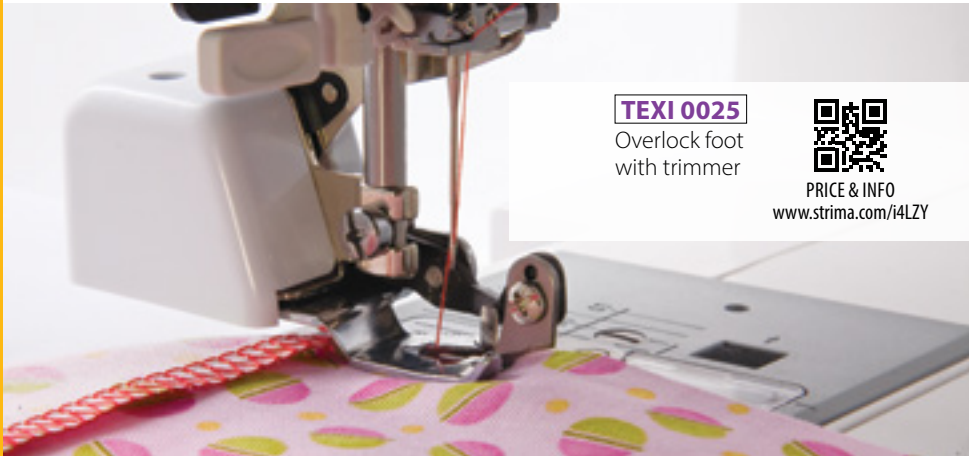

TEXI 0025
Overlock foot
with trimmer



PRICE & INFO
www.strima.com/i4LZY



TEXI 0026
Cord sewing foot



PRICE & INFO
www.strima.com/i4LZt

SYSTEM MATIC

Check what holder you have in your machine. Measure the height, from the bottom of the foot, to the screw that secures the handle to the needle bar. If the distance is about 1.5 cm, it means that we have a low type of foot mounting in our machine. The vast majority of household machines have this type of handle. If the distance from the bottom of the mounted foot to the screw is approximately 2.5 cm, it is a high foot mount.



MATIC FOOTERS

SYSTEM MATIC presser foot holder

TEXI 1001

Low fastening type
(holder height 1.5 cm)



PRICE & INFO
www.strima.com/i4LZv



MATIC 5 SEC.

TEXI 1002

High fastening type
(holder height 2.5 cm)



PRICE & INFO
www.strima.com/i4LZx



MATIC 5 SEC.

TEXI 1003

MATIC universal foot



PRICE & INFO
www.strima.com/i4LZy



TEXI 1004

MATIC universal foot,
plastic



PRICE & INFO
www.strima.com/i4La0



HOUSEHOLD ACCESSORIES

TEXI 1005
 MATIC sliding
 buttonhole foot



PRICE & INFO
www.strima.com/i4La1



TEXI 1009
 MATIC double-
 sided zipper foot



PRICE & INFO
www.strima.com/i4La5



TEXI 1006
 MATIC
 application foot



PRICE & INFO
www.strima.com/i4La2



TEXI 1010
 MATIC double
 hemming foot
 1/16" (1.6 mm)



PRICE & INFO
www.strima.com/i4La6



TEXI 1008
 MATIC button foot



PRICE & INFO
www.strima.com/i4La4



TEXI 1011
 MATIC adjustable
 guide foot



PRICE & INFO
www.strima.com/i4La7



TEXI 1012

MATIC cording foot



PRICE & INFO
www.strima.com/i4La8



TEXI 1013

MATIC overcast guide foot



PRICE & INFO
www.strima.com/i4La9

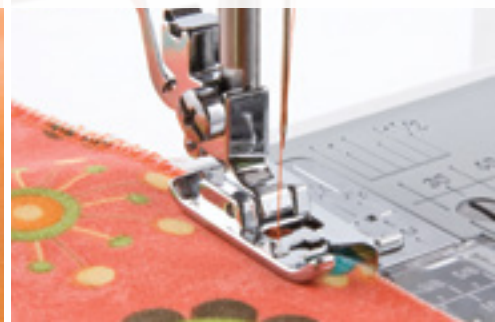

TEXI 2001

Binders and hemmers fastening handle



PRICE & INFO
www.strima.com/i4LaD



TEXI 1014

MATIC quilter's guide



PRICE & INFO
www.strima.com/i4LaA

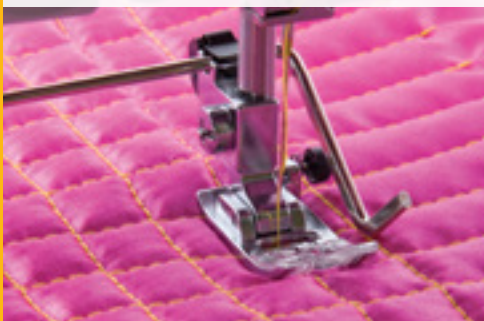

TEXI 1015

MATIC invisible zipper foot



PRICE & INFO
www.strima.com/i4LaB

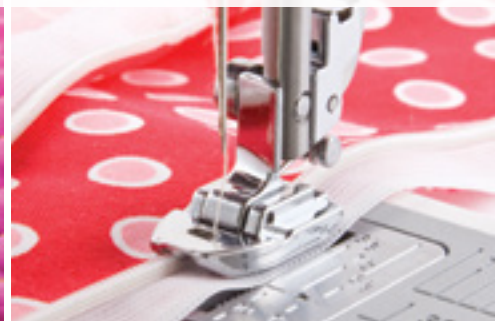

TEXI 1016

MATIC roller foot for difficult fabrics



PRICE & INFO
www.strima.com/i4LaC



TEXI 1017

MATIC bin justable 5-20 mm



PRICE & INFO
www.strima.com/i4LZZ



TEXI 2002

A = 7/32" (5,5 mm)

TEXI 2003

A = 1/10" (2,5 mm)

TEXI 2004

A = 1/4" (6,5 mm)

TEXI 2005

A = 3/8" (9,5 mm)

TEXI 2006

A = 5/8" (16 mm)

TEXI 2007

A = 7/8" (22 mm)



texi. Uniwersalne akcesoria



TEXI 3003 SET 3

Bobbin
(metal, flat)
3 pcs



PRICE & INFO
www.strima.com/i4La0



TEXI 3004 SET 3

Bobbin
(plastic, flat)
3 pcs



PRICE & INFO
www.strima.com/i4LaP



TEXI 3010 SET 3

Bobbin
(plastic, convex)
3 pcs



PRICE & INFO
www.strima.com/i4LaV



TEXI 4005

Tweezers



PRICE & INFO
www.strima.com/i4Laa



TEXI 4033

Storage box for 25
bobbins



PRICE & INFO
www.strima.com/i4Lb3



TEXI 4079

Set for cleaning the
machine



PRICE & INFO
www.strima.com/i4SE3

TEXI 4080

Clever
accessories
set for every
seamstress

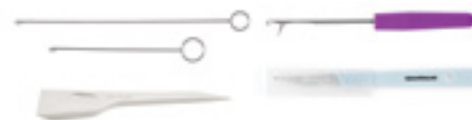

PRICE & INFO
www.strima.com/i4SE4

TEXI 4047

Loop turner



PRICE & INFO
www.strima.com/i4NfZ



TEXI 4083

Button hole cutting knife



PRICE & INFO
www.strima.com/i4Tu2



TEXI 4049

Knit picker



PRICE & INFO
www.strima.com/i4Nfb



TEXI 4048

Finger presser tool



PRICE & INFO
www.strima.com/i4Nfa



1.39 € NET



TEXI 4013

Pencil for fabrics: white + color



PRICE & INFO
www.strima.com/i4Laj

TEXI 4014

Disappearing pen violet - pink



PRICE & INFO
www.strima.com/i4Lal

TEXI 4015

Disappearing pen



PRICE & INFO
www.strima.com/s1016

TEXI 4016

Eraser for disappearing pen



PRICE & INFO
www.strima.com/i4Lan



TEXI 4040

Tailor chalk pen with applicator



PRICE & INFO
www.strima.com/s1017

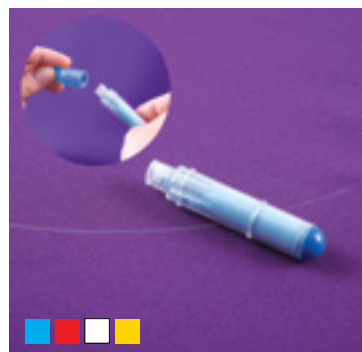

TEXI 4041

Refill for pen with applicator



PRICE & INFO
www.strima.com/s1018



flower heads

TEXI 4075

Flower head steel pins, nickel plated 0.6 x 48 mm, box of 80 pcs.



PRICE & INFO
www.strima.com/i4Nfr



glass heads

TEXI 4076

Steel pins, nickel plated 0.6 x 48 mm, box of 75 pcs.



PRICE & INFO
www.strima.com/i4Nfs



11,5 cm

TEXI 4046

Tailor's awl for piercing holes for rivets, snaps, eyelets



PRICE & INFO
www.strima.com/i4Nfy



TEXI 4082

Seam ripper



PRICE & INFO
www.strima.com/i4Tu1



TEXI 4029

Magnetic pin and needle holder



PRICE & INFO
www.strima.com/s1019

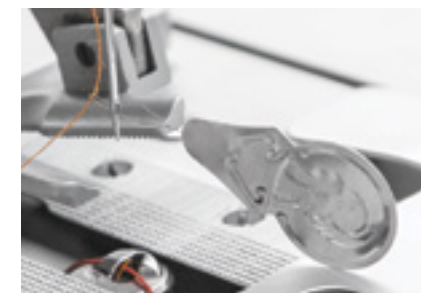

TEXI 4034

Needle threader



PRICE & INFO
www.strima.com/i4LaR



TEXI 4006

Cleaning roll with handle
(1 roll = 10 mts)



PRICE & INFO
www.strima.com/s1020

TEXI 4006R

Spare roll, tape length 10 mts



TEXI 4011

Brush for naps
lifting



PRICE & INFO
www.strima.com/i4Lah

TEXI 4035
Tape makers set:
TEXI 4036 + TEXI 4037 + TEXI 4038



PRICE & INFO
www.strima.com/i4Ma6

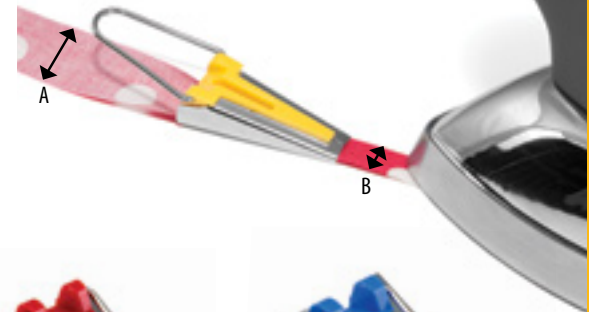

TEXI 4036

A = 24 mm
B = 12 mm



PRICE & INFO
www.strima.com/i4Ma7



TEXI 4037

A = 36 mm
B = 18 mm



PRICE & INFO
www.strima.com/i4Ma8



TEXI 4038

A = 50 mm
B = 25 mm



PRICE & INFO
www.strima.com/i4Ma9



TEXI BOX 15

Set of thread 15 colors, household
machine needles and leaflet



PRICE & INFO
www.strima.com/i4Rwi



TEXI 4020

Iron foot cleaning stick



PRICE & INFO
www.strima.com/i4Laq



TEXI 4001

PTFE anti-shine



PRICE & INFO
www.strima.com/i4LaW



TEXI 4002

Thermal adhesive powder



PRICE & INFO
www.strima.com/i4LaX

texi. Craft
Premiéra
na podzim

texi. Craft Cutting mats and rulers



PRICE & INFO
www.strima.com/s1021

TEXI CRAFT YELLOW 45 X 30 SET

The kit includes: rotary cutter 45mm, cutting mat, ruler, sewing clips, craft knife, anti slip stickers

19.90 € NET

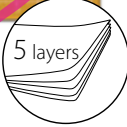
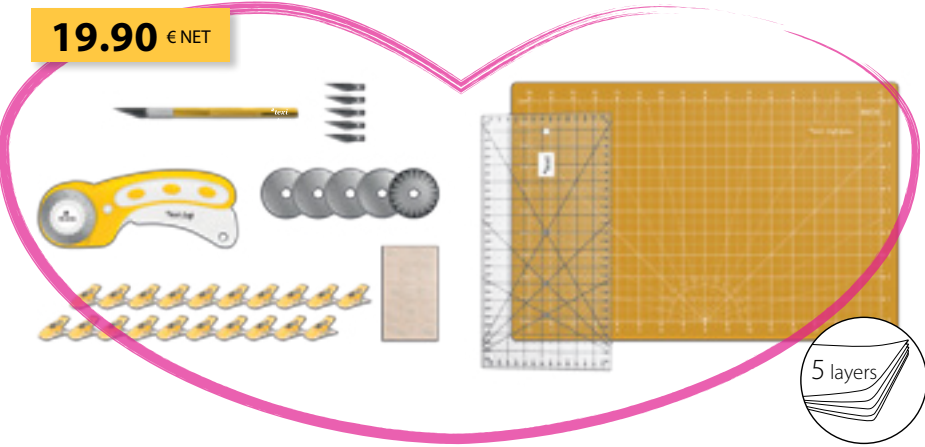

EASY PEASY
CRAFTING IN GOOD PRICE



TEXI CRAFT PINK 60 X 45 SET

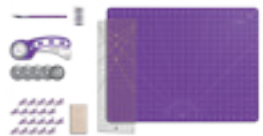

TEXI CRAFT PURPLE 60 X 45 SET



TEXI CRAFT BLACK 90 X 60 SET

15 x 30 cm
 black

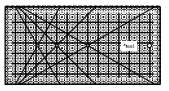

15 x 45cm
 yellow

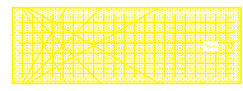

15 x 45 cm
 black

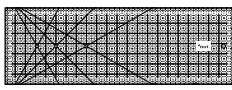

15 x 60cm
 yellow

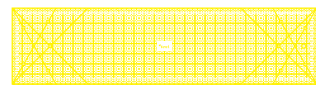

You don't need the set - choose separately!



Sewing clips
 38 x 11 x 15 mm, color mix

Texi 4097

20 pcs



PRICE & INFO
www.strima.com/i4UI3

Texi 4098

50 pcs



PRICE & INFO
www.strima.com/i4UI4



TEXI 4106

Rotary cutter, Ø 45 mm



PRICE & INFO
www.strima.com/i4UIC



TEXI 4107

Craft knife



PRICE & INFO
www.strima.com/i4UID

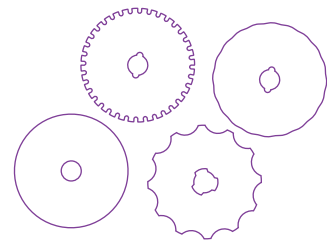

Texi Rotary Cutter Blades

Ø 45 mm:
 straight, pinking, 2 x wavy, 3 x skip



PRICE & INFO
www.strima.com/s1030

TEXI YELLOW

45 x 30 cm
 60 x 45 cm
 90 x 60 cm

TEXI BLUE

45 x 30 cm
 60 x 45 cm
 90 x 60 cm

TEXI PINK

45 x 30 cm
 60 x 45 cm
 90 x 60 cm

TEXI BLACK

45 x 30 cm
 60 x 45 cm
 90 x 60 cm



PRICE & INFO
www.strima.com/s1022

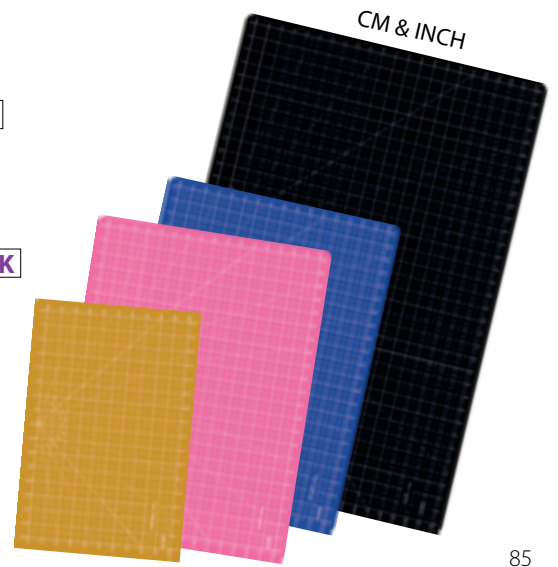



TEXI 4065

Quilting ruler, metric scale,
160 x 320 mm, black



PRICE & INFO
www.strima.com/i4Nfm

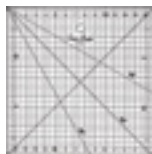

TEXI 4066

Quilting ruler, metric scale,
160 x 160 mm, black



PRICE & INFO
www.strima.com/i4Nfm



TEXI 4067

Quilting ruler, metric scale,
160 x 320 mm, yellow



PRICE & INFO
www.strima.com/i4Nfo



TEXI 4068

Ruler handle - 2 caps



PRICE & INFO
www.strima.com/i4Nfp



TEXI 4069

Ruler handle - 1 cap



PRICE & INFO
www.strima.com/i4Nfq



TEXI 4007

Tailor's tape measure,
length 150 cm,
width 19 mm



PRICE & INFO
www.strima.com/i4Lac



TEXI 4008

Rollfix textile tape measure
- reversible 150 cm



PRICE & INFO
www.strima.com/i4Lae



PRICE & INFO
www.strima.com/s1023

texi Rotary Cutters



TEXI 4050

∅ 18 mm



TEXI 4051

∅ 28 mm



TEXI 4052

∅ 45 mm



TEXI 4053

∅ 45 mm



TEXI 4054

∅ 60 mm

Rotary cutter blades



straight



skip



wave

∅ 18 mm	∅ 28 mm	∅ 45 mm	∅ 60 mm
— TEXI 4055	— TEXI 4056 - - TEXI 4058 ~ ~ TEXI 4059	— TEXI 4057	— TEXI 4060



MODEL	SURFACE	HEIGHT ADJUSTMENT	BOARD POWER	IRON POWER	VACUUM	BLOWING	STEAM GENERATOR POWER	ONE FINGER OPERATION	SLEEVE BUCK
TEXI BIB	40 x 120 cm	81 - 100 cm	-	-	-	-	-	-	-
TEXI CHAMPION S	45 x 120 cm	85 - 102 cm	400 W	-	35 W	-	-	-	-
TEXI CHAMPION SB	45 x 120 cm	85 - 102 cm	400 W	-	35 W	35 W	-	-	-
TEXI HESTIA	43 x 110 cm	70 - 95 cm	250 W	850 W	50 W	50 W	1 150 W	-	-
TEXI SMART S+B	45 x 120 cm	60 - 105 cm	200 W	800 W	40 W	40 W	1 300 W	✓	✓



TEXI BIB

Iron table, chromium-plated, 40 x 120 cm



PRICE & INFO
www.strima.com/i4TKL

TEXI CHAMPION S

Ironing table board type 45 x 120 cm, with suction and heated surface

TEXI CHAMPION SB

Ironing table board type 45 x 120 cm, with suction, blowing and heated surface

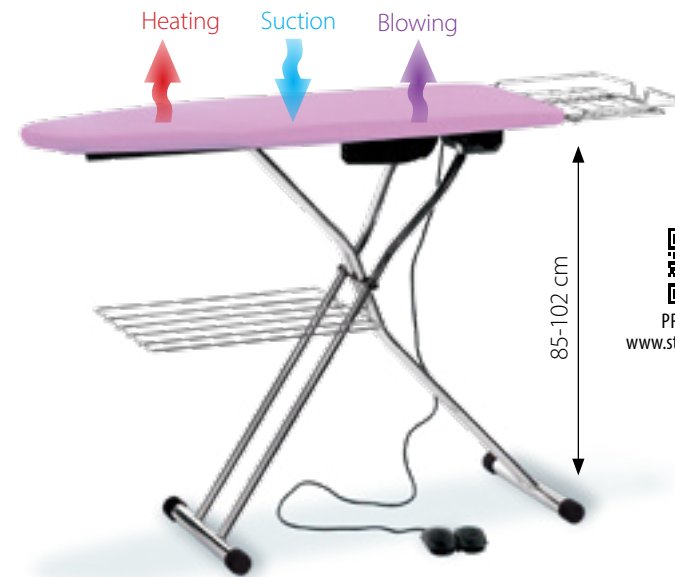

PRICE & INFO
www.strima.com/s1024

Additional equipment

TEXI SLEEVE BUCK

Universal ironing sleeve buck, 52 cm long



PRICE & INFO
www.strima.com/i4LYq

TEXI HESTIA

Compact ironing table with automatic, integrated steam generator and iron, PTFE shoe for iron and bottle for filling steam generator tank for FREE



PRICE & INFO
www.strima.com/i4NxW

Additional equipment

TEXI HESTIA IRON PTFE SHOE

PTFE shoe for TEXI HESTIA iron



PRICE & INFO
www.strima.com/i40G0



TEXI SMART S+B

Ironing table with automatic steam generator and iron with intelligent programming of fan operation time



CENA | INFO
www.strima.com/i4Mxf

Additional equipment

PTFE shoe + TEXI SMART S+B BRUSH

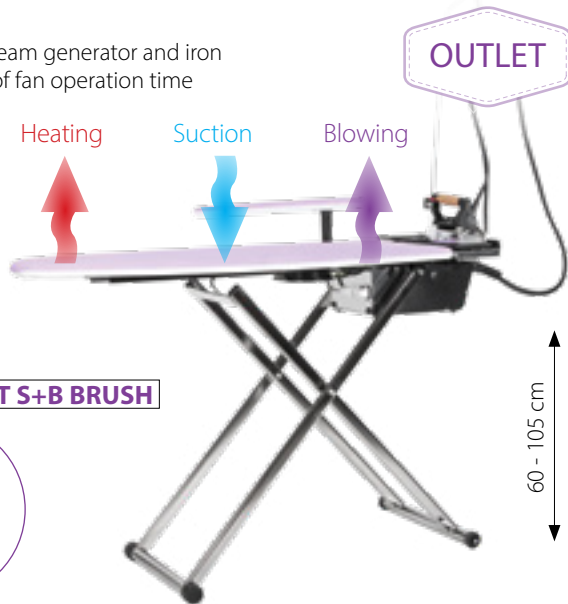
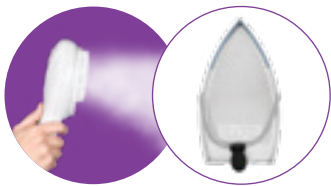

✉ sales@strima.com

texi Steam presses

Electronically controlled steam press



PRICE & INFO
www.strima.com/s1025

TEXI APOLLO 68

199 € NET

TEXI APOLLO 68

Ironing surface
66 x 26 cm, 1600 W

TEXI APOLLO 101

Ironing surface 99 x 29 cm, 2200 W



Force of 18 irons

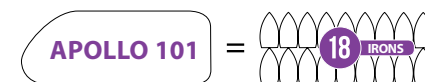
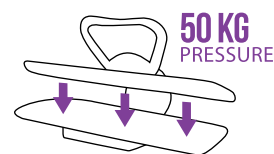

REMEMBER ABOUT:

Apollo steam press stand,
height 93 cms



CENA | INFO
www.strima.com/i403Y

Apollo steam press telescopic stand,
height 63-73 cm



CENA | INFO
www.strima.com/i403Z



TEXI MASTER PLUS

Steamer

- ✓ power 2200 W
- ✓ water capacity 3,8 l
- ✓ 12 level steam control



PRICE & INFO
www.strima.com/i4Tup



Master Plus
PROFESSIONAL STEAMER

139 € NET



texi Fastening

TEXI 75S TAG GUN

Tagging gun - standard

4.30 € NET



PRICE & INFO
www.strima.com/s1026

TEXI 75F TAG GUN

Tagging gun for fastening labels with fine tagging pins



texi Tagging pins



PRICE & INFO
www.strima.com/s1028

TEXI 75S NEEDLE

Standard 1,85 mm



TEXI 75S NEEDLE PREMIUM

Standard 1,85 mm



TEXI 75F NEEDLE

Fine 1,32 mm



PRICE & INFO
www.strima.com/s1027



TEXI 75F NEEDLE PREMIUM

Fine 1,32 mm



TEXI 75 PPS standard

1	TEXI 75 PPS BLACK	15 mm
2	TEXI 75 PPS BLACK	25 mm
3	TEXI 75 PPS BLACK	45 mm
4	TEXI 75 PPS BLACK	65 mm
5	TEXI 75 PPS	15 mm
6	TEXI 75 PPS	25 mm
7	TEXI 75 PPS	45 mm
8	TEXI 75 PPS	65 mm

TEXI 75 PPF fine

9	TEXI 75 PPF BLACK	15 mm
10	TEXI 75 PPF BLACK	25 mm
11	TEXI 75 PPF BLACK	45 mm
12	TEXI 75 PPF BLACK	65 mm
13	TEXI 75 PPF	15 mm
14	TEXI 75 PPF	25 mm
15	TEXI 75 PPF	45 mm
16	TEXI 75 PPF	65 mm

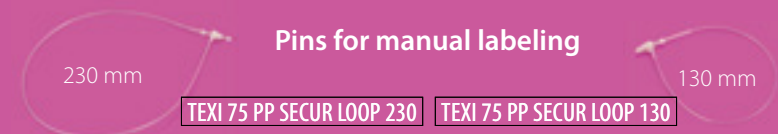

Pins for manual labeling

TEXI 75 PP SECUR LOOP 230

TEXI 75 PP SECUR LOOP 130

STRIMA[®] Worldwide distributor of the *texi*[®] brand

Respect and kindness
to our customers
in 94 countries

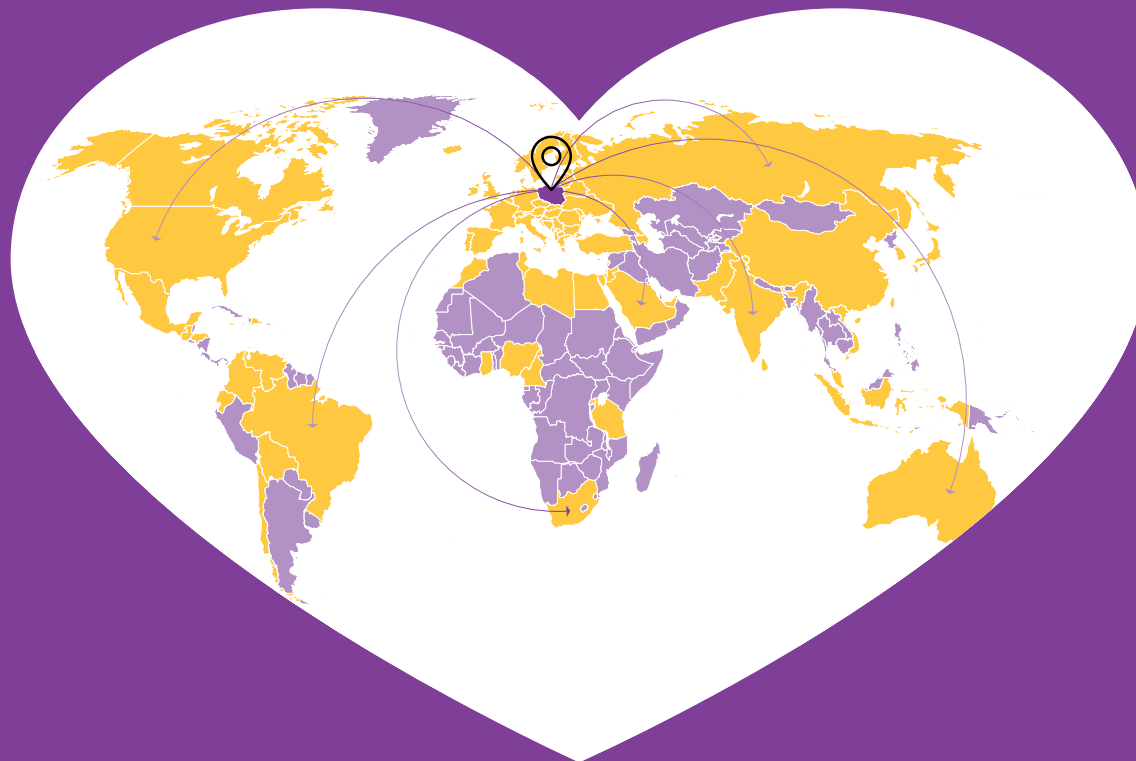

Strima Sp. z o.o.

Swadzim, Poznanska Street 54
62-080 Tarnowo Podgorne, Poland

☎ +48 61 8 950 950
🖨 +48 61 8 950 951

✉ shop@strima.com





 *texi*®

Distributed by

www.strima.com