

# **INSTRUCTIONS AND MAINTENANCE**

## **PNEUMATIC ZEUS/A mod. 2009**

***Read this manual carefully before operating.***

***Don't use the machine differently from the following instructions.***

### **1. SPECIFICATIONS**

MODEL:	<b>PNEUMATIC ZEUS/A mod. 2009</b>
POWER SUPPLY:	V 400 + NEUTRAL
TOTAL INSTALLED POWER:	W 11850
BOILER POWER:	W 9000
VACUUM/BLOWING MOTOR POWER:	HP 1,75 / HZ. 50
PUMP POWER:	HP 0,8 / HZ. 50
BOILER CAPACITY:	L. 10
IRONING ENDURANCE:	CONTINUOUS
OPERATING STEAM PRESSURE:	BAR 4,5
WEIGHT:	KG. 160
OVERALL DIMENSIONS:	cm 150x195x170 h.
MADE IN ITALY	

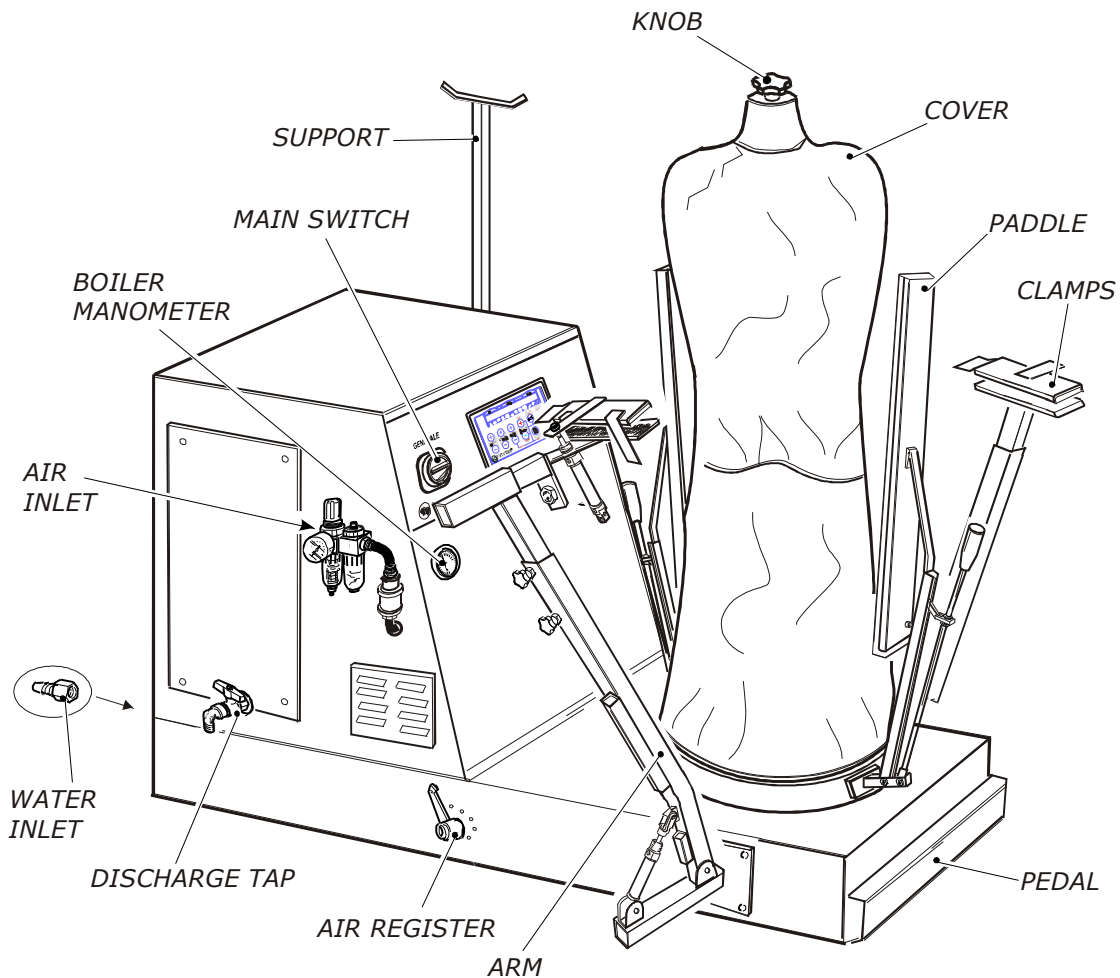

**Fig. 1**

## 2. IMPORTANT

Before installing ZEUS, it is necessary to set up the following facilities next to where it will be installed:

1. a water connection (tap with hose holder). ZEUS will be connected to the tap with hose holder named WATER INLET (**fig. 1**) thanks to a rubber hose with a pressure capacity of at least 10 ATM. (diameter of water inlet 8/13 mm) and which must be fixed tightly with 2 hose clamps. **N.B.** before inserting the rubber hose into ZEUS hose holder, exhaust a few litres of water in order to clean the conduit;
2. a grounded outlet suitable to ZEUS power;
3. a compressed air tube able to supply a constant pressure of at least 8/10 bar.
4. **N.B. The blowing motor is three-phase. Should it work, but not blow, invert two phases on the electric feeding.**

## 3. OPENING OF PACKAGE

1. Open the box containing ZEUS from the upper side marked ALTO , take out the instructions handbook and read it carefully.
2. Remove ZEUS from the box and fix the support for clamps (**fig. 1**).

## 4. "STANDARD" & "STAND-BY" MODE

By turning on the main switch the machine is in "*stand-by*" mode. (red led on). This mode allows access to the SET menu in order to set functions such as: language, periodical maintenance warnings etc. – see point 6):

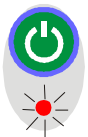

Electronic card in **stand-by** mode. If maintenance should be required (filter cleaning, cover changing, ...) a warning will inform you which intervention is needed. The warning will disappear once the intervention has been done and the RESET button has been pressed (see point 9).

By pressing the start button, the machine is in "*standard*" mode. This allows to set the ironing functions (i.e. speed of motors, temperature of ironing board, iron functioning etc.):



Electronic card in **standard** mode.







To temporarily turn off the machine you may press the start button: the machine will go into stand-by mode and the red led will turn on. However, the electronic card will continue to receive power from the mains supply.

**At the end of each working day we suggest to always turn the machine off by using the main switch (fig. 1).**

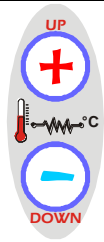
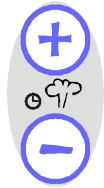
**WARNING:** the electronic card automatically performs a check of the software installed. If an error or fault is found the "safety" device blocks the electronic card and does not allow normal functioning. "SOFTWARE UPDATE NEEDED" will be displayed. Contact the Authorized Service Centre to update the software.

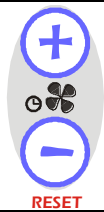

## 5. USE OF KEYS - STANDARD MODE



Verify that the electronic card is in "standard" mode.

	<p>"Super-heater temperature" increase/decrease keys. Adjustable from 120°C to 260°C. Upon pressing one of the keys the temperature set by the operator will be displayed (SUPER-HEATER TEMPERATURE). If no key is pressed after 5 seconds, the timings for the 3 phases will be displayed (steam, air-steam, air).</p>
	<p>"Steam phase timing" increase/decrease keys. Timing may be set from 0 to 99 seconds.</p>
	<p>"Air-steam phase timing" increase/decrease keys. Timing may be set from 0 to 99 seconds.</p>
	<p>"Air phase timing" increase/decrease keys. Timing may be set from 0 to 99 seconds.</p>
	<p>"Clamp exclusion" key (pneumatic version)</p>
	<p>Key to visualize memorized ironing programs.</p>
	<p>"Boiler on/off" key.</p>

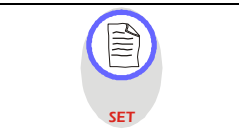



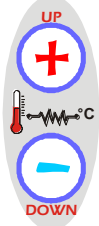



## 6. USE OF KEYS – STAND-BY MODE

Verify that the electronic card is in "stand-by" mode.

<p><b>SET</b></p>		<p>By pressing the key while the electronic card is in stand-by mode, it allows you to enter and exit the SET menu.</p>
<p><b>OK</b></p>		<p>Key which allows you to confirm the choice made within the SET menu.</p>

<b>ESC</b>		Key which allows you to exit the current function.
<b>UP DOWN</b>		Key which allows you to scroll up or down.
<b>RESET</b>		Key which allows you to reset warnings such as: filter cleaning, probe cleaning, cover changing and zeroing of partial hours.

## 7. MEANING OF ICONS

	Signals that the water inside the boiler is being heated in order to obtain the correct operating pressure. When this icon turns off it means that the boiler has reached the optimum pressure.
	Signals that the pump is pumping water into the boiler.
	Signals that the super-heater is warming up in order to reach the temperature set. When this icon turns off it means that the super-heater has reached the right temperature.
	Signals that the pump is blocked due to the fact that it has worked without water for a long time. Check that water comes out of the pipe connected to the water supply. Turn off the main switch, wait for 5 seconds and turn the machine on again. If the problem reoccurs, contact Authorized Service Centre.
	Signals an overheating of the motor (see motor overheating).
<b>SET</b>	Signals that the electronic card is in SET mode and data may be set (see SET & RESET).
	Signals a malfunctioning of the temperature probe of the super-heater. <b>WARNING:</b> A safety device will block the heating of super-heater. Contact Authorized Service Centre.
	Signals that the maximum number of hours set for the replacement of the cover has been exceeded. Change the cover and reset the warning (see SET e RESET)
	Signals that the maximum number of hours set for the cleaning of the water filter has been exceeded. Clean the water filter and reset the warning. (see CLEANING OF FILTER -SET & RESET).
	Signals that the maximum number of hours set for the general maintenance of the machine has been exceeded. Contact the manufacturer or Authorized Service Centre for this intervention.



Signals that the maximum number of hours set for the cleaning of the boiler's probe has been exceeded. Clean the probe and reset the warning (see CLEANING OF PROBE - SET & RESET ).



Signals an anomalous overheating of the boiler. The type of warning can be read on the display. WARNING: a safety device will block the heating of the water inside the boiler or the heating of the super-heater. Turn off the main switch and wait for half an hour. If the problem reoccurs, contact Authorized Service Centre.

## 8. CONNECTION AND STARTING

1. Place ZEUS on a plain clean floor, at least 2 metres far from other appliances, from metal-enclosed bus ducts and from electric or electronic parts.
2. Connect the water rubber hose to the ZEUS hose holder called WATER INLET (**fig. 1**) and turn the water tap.
3. Connect the power supply cable to a grounded outlet, with observance of the law in force and a voltage suitable to ZEUS.
4. Connect the compressed air tube to the pressure adapter and adjust it to a maximum pressure of 6 bar (**fig. 6**).
5. Turn on the main switch and the electronic card (see key table). Select which functions are to be activated and which to be deactivated (clamps, boiler, ...). If the main switch is turned off the functions previously set will be memorized so that they will automatically be activated once the machine is switched on again.

## 9. SET e RESET





To gain access to the SET menu, the electronic card must be in "stand-by" mode. Press the key shown on the left. To exit the SET mode, press the key once again or wait for 5 seconds.

SET menu:

HOURS OF WORK		 	TOTAL HOURS :	  	To exit 
			PARTIAL HOURS :		

TOTAL HOURS: computation of the total hours the machine has worked for. This data cannot be zeroed.

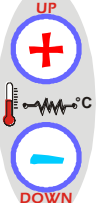
PARTIAL HOURS: computation of the hours the machine has worked for since the last zeroing. This data can be zeroed (see table).

WARNING RESET			FILTER		To exit 
			COVER		
			PROBE		

Reset is necessary in order to delete the warnings from the display once maintenance has been done.



Example: WARNING: PROBE CLEANING NEEDED is displayed.

1. Gain access to SET,
2. find RESET WARNINGS
3. press OK and find PROBE.
4. press OK, RESET and then OK once again.
5. ESC to exit the SET menu.

N.B. the warnings may be reset only if they are shown on the display.

MAINTENANCE	Password needed. Service Centre authorized access only.
MANUFACTURER	Password needed. Manufacturer authorized access only.

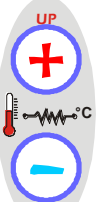
**WARNING:** AFTER 10 ATTEMPTS TO ACCESS THE "MAINTENANCE" OR "MANUFACTURER" MENU WITHOUT TYPING IN THE PASSWORD AND/OR BY TYPING THE WRONG PASSWORD, THE SET MENU WILL BE BLOCKED. "PASSWORD INSERTION BLOCKED" will be displayed. To unblock the set menu, contact the Authorized Service Centre.

LANGUAGE			ITALIAN	To confirm language 	To exit 
			ENGLISH		
			GERMAN		
			FRENCH		
			SPANISH		
			PORTUGUESE		

This menu allows the setting of the language.

## 10. USE OF STEAM SUPER-HEATER

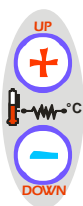

It is recommended to adjust the steam super-heater between 120°-150° C. In any case you can increase or decrease the temperature by pressing the keys, thus obtaining a drier or more saturated steam. Every time the temperature setting is changed, it will be displayed.

## 11. USE OF CLAMPS

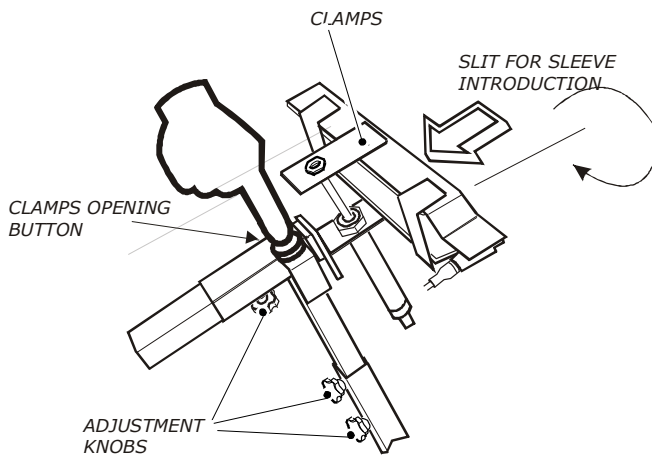

Fig. 2

The functioning of clamps and arms is automatic. You just need to insert the garments sleeves into the special slit; as soon as Zeus notices the presence of the sleeves, it will tighten the clamps. If the sleeves are inserted incorrectly, by pushing for a couple of seconds the clamps opening button, the sleeves will be freed. It is possible to adjust height and distance of the clamps by using the special knobs (**fig. 2**). You can also turn the clamps on vertical position.

## 12. USE OF PADDLE

The dummy is fitted with two paddles (**fig. 1**): the front paddle is used for closing the opening of the garment without having to button it, whereas the back one is used for fastening of the slits or the central pleat of the garment. The operator can release the paddle by grasping the handle and pulling the racket with one's thumb (**fig. 3**). In addition, by turning the handle clockwise or anticlockwise, you can adjust the pressure exerted by the paddle on the garment, preventing it from slipping away or being marked.

## 13. SHOULDERS AND BLOWING MOTOR ADJUSTMENT

Upon the first working cycle and each time the fabric to iron is changed, it is necessary to set up the following adjustments:

1. Place the garment on the body former and adjust the shoulders width by means of the proper knob (**fig. 1**). The body former shoulders must coincide with the garment shoulders.
2. Regulate the paddle (see point **12**).
3. Adjust the air register according to the program which has been chosen or according to your requirements. Example: when program 1 is selected, "CHILDRENS SWEATSHIRT ADJ. AIR 1" will be displayed.

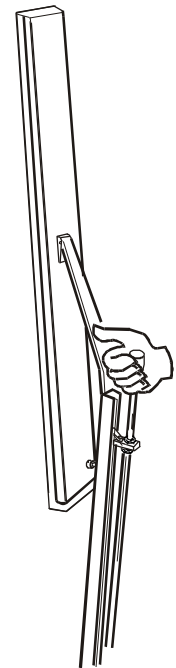

Fig. 3

**N.B. The blowing motor is three-phase. Should it work, but not blow, invert two phases on the electric feeding.**

## 14. ARMS AND CLAMPS PRESSURE ADJUSTMENT

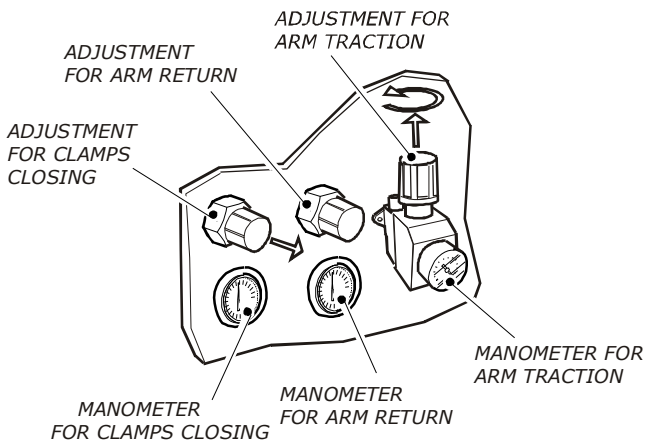

Fig. 4

It is possible to adjust the closing pressure of the clamps and the traction (opening) and return (closing) pressure of the arms by using the special knobs. By increasing the pressure, the force exerted on the garment by clamps and arms increases, too. On the relative manometers, you can see the chosen pressure (**fig. 4**). Make these adjustments in such a way that the garment does not slip away from the clamps and it is simultaneously well stretched by the arms.

- N.B.:** should it happen that at the end of the cycle the arms do not close, increase their closing pressure. On the other hand, should they close down too quickly, just decrease the pressure;
- N.B.:** do not increase the pressure of the clamps too much; a high pressure might cause hand injuries if accidentally pressed by the clamps. Should it occur, push immediately on the opening button (**fig. 2**).

## 15. ADJUSTMENT OF OPENING AND CLOSING SPEED OF ARMS AND CLAMPS

It is possible to adjust the opening and closing speed of arms and clamps by using the special screw on the four little pistons and following these instructions (**fig. 5**):

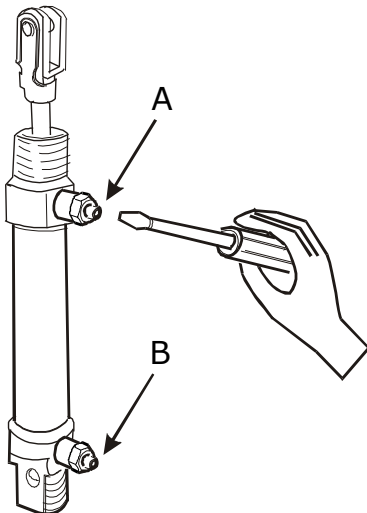

Fig. 5

### LITTLE PISTONS ON CLAMPS

**SCREW A:** turn anticlockwise to increase the closing speed of the clamps, clockwise to decrease it.

**SCREW B:** turn anticlockwise to increase the opening speed of the clamps, clockwise to decrease it.

### LITTLE PISTONS ON ARMS

**SCREW A:** turn anticlockwise to increase the closing speed of the arms, clockwise to decrease it.

**SCREW B:** turn anticlockwise to increase the opening speed of the arms, clockwise to decrease it.



## 16. USE OF MEMORIZED IRONING PROGRAMS

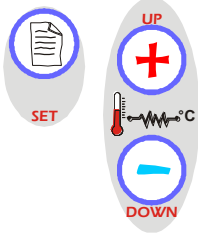

By pushing the key shown on the left it is possible to choose between the 20 stored ironing programs. The UP, DOWN keys are used to scroll the pre-stored ironing programs as well as a manual personalized program. It is possible to immediately skip to the "OPERATOR" program by pressing the SET key and then ESC

IRONING PROGRAM	SUGGESTED AIR ADJUSTMENT	STEAM	AIR/STEAM	AIR
		SECONDS	SECONDS	SECONDS
CUSTOMER		May be set by operator	May be set by operator	May be set by operator
1° CHILDRENS SWEATSHIRT	1	4	0	4
2° MENS SWEATSHIRT	1	5	0	5
3° CHILDRENS SMOCK	1	6	5	5
4° T-SHIRT	2	10	0	6
5° DRY SHIRT	2	10	3	7
6° SHORT-SLEEVED SHIRT	2	8	3	6
7° WORKING SHIRT	1	6	5	6
8° LIGHT JACKET	2	5	7	5
9° HEAVY JACKET	3	6	10	6
10° LEATHER JACKET	1	6	10	6
11° COAT	3	6	10	6
12° MENS SPORTS JACKET	1	10	5	6
13° LIGHT LADIES DRESS	1	8	0	4
14° KNITTED LADIES DRESS	1	10	4	6
15° DAMP SHIRT 1°	2	15	10	45
16° DAMP/WET SHIRT 2°	3	20	10	60
17° WASHED OUT JACKET	3	10	6	6
18° JEANS JACKET	3	10	10	10
19° LINEN JACKET	2	15	10	10
20° HEAVY SHIRT	2	12	5	10

The **CUSTOMER** program allows the operator to create and store a "working cycle" according to the timings desired. Choose the manual program, wait for 5 seconds until the timings of the various phases appear and then set the desired values, which will be stored automatically.

The other pre-stored programs may be modified by the operator, but when voltage is cut off or when other programs are used, the modifications will be cancelled and the values stored by the manufacturer will be set.

According to the ironing program chosen the suggested air adjustment will be displayed (Fig.1). Example: KNITTED LADIES DRESS air adj 1

N.B. the setting of the super-heater's temperature does not depend on the program chosen, therefore the latest setting remains stored.

## 17. WORKING CYCLE

After having started the boiler (when the boiler is under pressure the "steam" icon will turn off), carried out all the adjustments and chosen the program, ZEUS is ready for use.

To start the automatic cycle, just insert the sleeves into the clamps. ZEUS will automatically tighten them. Now press the pedal (**fig. 1**). This way the arms get in traction and the steam cycle is activated, then the air-steam cycle and, eventually, the hot air cycle. The various phases and timings are shown on the display. Once the working cycle has finished, the clamps open and the arms close down; the operator can start another cycle.

**N.B. The working cycle does not start if the temperature of the super-heater is below 120°C and/or if both the clamps have not closed themselves correctly. If the clamps are not necessary, follow instruction as per chapter "Deactivation and activation of arms and clamps".**

Note:

1. it is possible to interrupt the working cycle anytime by pressing the pedal;
2. each time you change the type of fabric to iron, and especially when changing from heavy fabrics to delicate ones, just repeat the settings at points **13** and **14**;
3. it is not possible to change the timings of the various phases during the working cycle.

## 18. DEACTIVATION AND ACTIVATION OF ARMS AND CLAMPS

Whenever you don't need arms and clamps, you can deactivate them and go on with the normal ironing cycle.

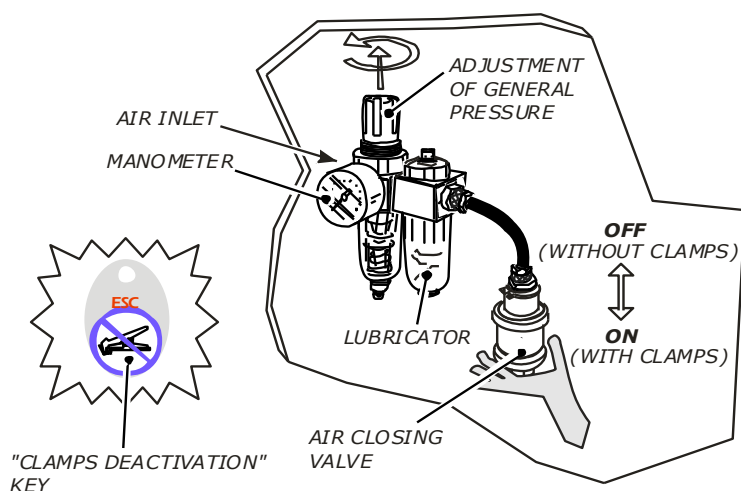

**Fig. 6**

In order to deactivate the clamps just follow these points:

1. Press the "clamps deactivation" key (the led will turn on)
2. Turn the air closing valve to position **OFF** (no clamps) (**fig. 6**).

In order to reactivate the clamps just follow these points:

1. Press the "clamps deactivation" key (the led will turn off)
2. Turn the air closing valve to position **ON** (with clamps) (**fig. 6**).

**WARNING! For a good functioning of the ironing cycle remember to press the key and turn the valve.**

## 19. COMPULSORY

1. Use only tap water.
2. Never add additives to water.
3. Empty the boiler once a week, making sure the boiler pressure is not over 0,5 BAR (**fig. 1: manometer**). To carry out this operation, open the exhaust tap very slowly. We advise you to wear gauntlets against possible burns.
4. Connect ZEUS to a suitable protected outlet.
5. After ironing is finished, switch off the main switch, close the water and the compressed air. Remember to open the water before switching on the machine again.
6. Always keep children away from the machine, both when it is on and off.
7. Make sure that during the cold season the tubes connecting the ZEUS to the water supply do not freeze.
8. If the machine is not used for a long period of time, switch off the main switch.



## 20. ELECTRICAL RISKS

The following situations are considered risky from an electrical point of view and therefore could be dangerous for the operator:

1. damaging of electrical cables of the iron;
2. the earth protector switch is activated when switching on the main switch;
3. using ZEUS during thunderstorms;
4. using ZEUS without proper protection for feet (without shoes...) or with wet feet;
5. loss of water from ZEUS base;
6. loss of steam from inner part of ZEUS.

## 21. MECHANICAL RISKS

The following situations are considered risky from a mechanical point of view and therefore could be dangerous for the operator:

1. using ZEUS for different uses other than ironing;
2. using ZEUS dummy without opening the water tap or with the aqueduct not supplying water;
3. using ZEUS while the pump keeps functioning and no water enters into the boiler because the entrance is obstructed by limestone;
4. using ZEUS when the boiler pressure is too high and the internal safety valves are activated. The pressure can be visibly controlled through the manometer;
5. putting one's hands into the clamps.

## 22. THERMAL RISKS

The following situations are considered risky from a thermal point of view and therefore could be dangerous for the operator:

1. emptying the boiler when it is under pressure.

## 23. INTERVENTIONS AND SMALL REPAIRS

TO BE CARRIED OUT WITH THE MACHINE COLD AND SWITCHED OFF.

1. Replace the dummy cover (**fig. 1**) every 700 hrs. of operation or maximum 6 months. A dirty or ruined cover reduces the performance of the machine. Wash or replace the dummy cover even earlier if it is ruined (the necessary substitution of the cover is signalled by the icon on the display).
2. Clean the water inlet filter (**fig. 7**) by following the instructions (the necessary cleaning of the filter is signalled by the icon on the display). See "cleaning of water filter".
3. For **six-monthly cleaning** of ZEUS, follow these instructions:
  - open the side and back panels,
  - clean the inner part with compressed air, with special care to the ventilator fan of the blowing motor.
4. Check and - if needed - feed the lubricator with oil (**fig. 6**).

## 24. CLEANING OF WATER FILTER

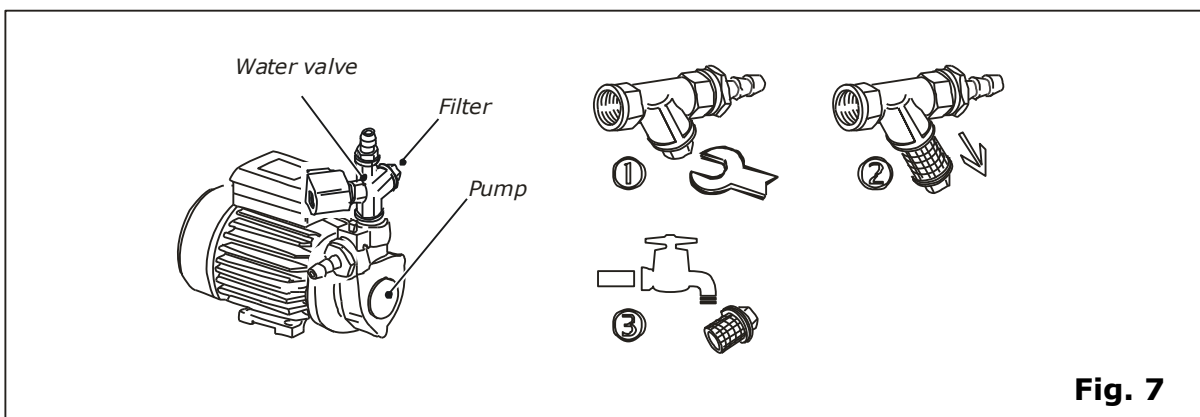

**Fig. 7**

Cleaning of the water filter is to be done whenever the warning is displayed. If the water is full of impurities, cleaning should be done more often.

To clean the water filter:

1. close the main water supply tap;
2. unscrew the filter plug by using a wrench as shown above;
3. take out the filter;
  1. by using running water, clean the filter in order to eliminate all impurities;
  2. re-assemble the filter, fix with the wrench and open the main water supply tap, checking that there are no leakages.

## 25. CLEANING OF BOILER PROBE

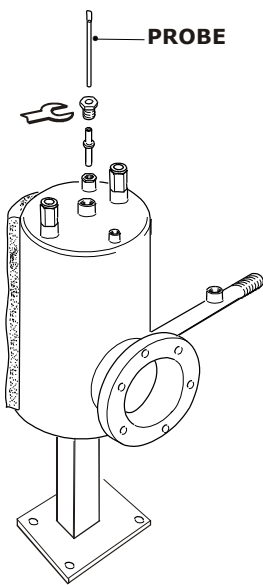

To clean the probe of the boiler, do as follows:

1. open the rear panel of the machine;
2. find the boiler and the probe;
3. unscrew the probe by using a wrench and take it out;
4. clean the probe with fine grain scrubbing paper in order to eliminate all encrustation;
5. re-assemble the probe and check that there are no leakages when the boiler is under pressure

## 26. MOTOR OVERHEATING

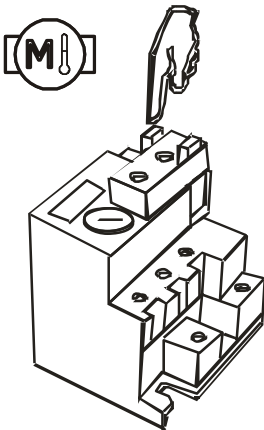

Fig. 8

The lightening up of the respective icon signals that the motor is overheated and has been under stress. In this case clean the motor and remove any dust which has gathered on it. The icon may also lighten up in the event of lack of one of the three phases on the motor. In this case check the power current fuses (see SUBSTITUTION OF POWER CURRENT FUSES).

To restart the machine do as follows:

- set the main switch on position "0";
- unscrew the 4 screws of the panel;
- find the motor protector and reset it by pressing the key (**see fig. 8**).
- screw the screws back on and start the machine.

## 27. SUBSTITUTION OF FUSES ON THE ELECTRONIC CARD

Substitution of fuses is required when a short circuit or an overload occurs.

**WARNING!:** before replacing the fuse it is important to eliminate the cause which determined its breakage.

To gain access to the fuses the main switch must be on pos. "0" and the four screws are to be unscrewed from the panel. The positioning of the fuses is indicated in **Fig. 9**. In order to replace a fuse, unscrew it by using a screwdriver and turning it anticlockwise, being careful to exert only a slight pressure. To re-assemble it, do the opposite.

**N.B.:** SUBSTITUTE FUSES WITH INTERCHANGEABLE ONES AND WITH THE SAME PERFORMANCE.

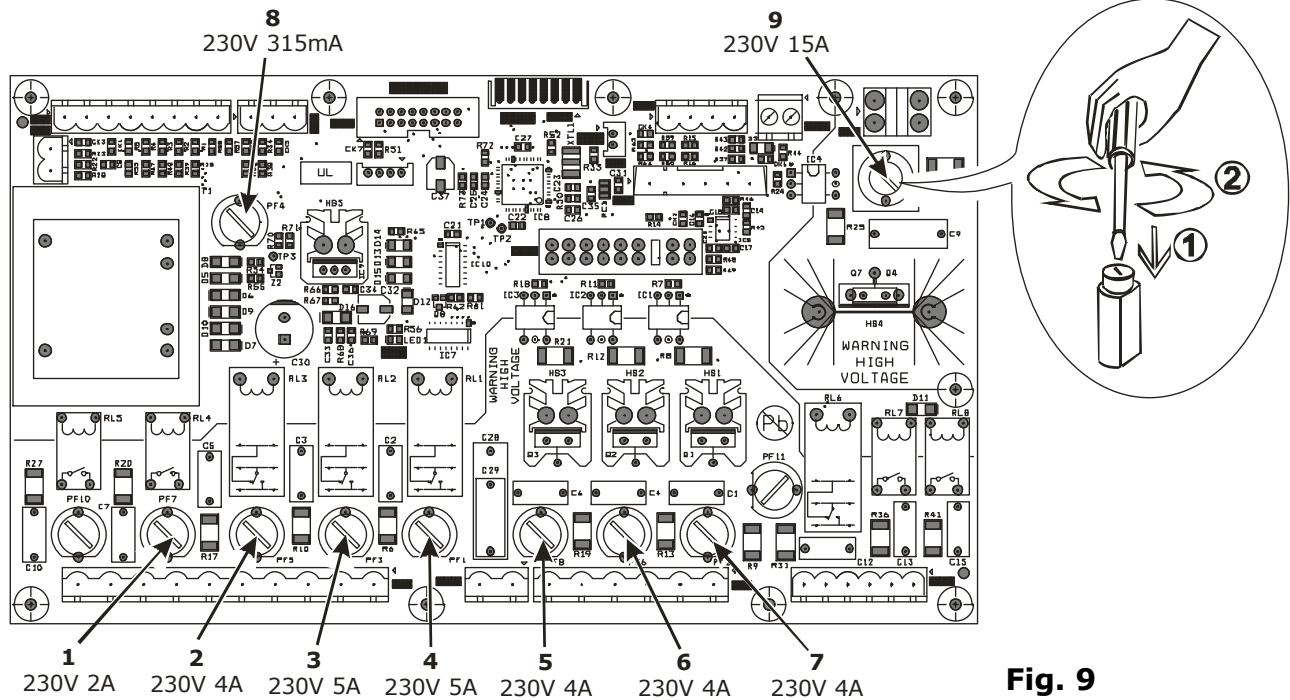

**Fig. 9**

- |                         |                        |                            |
|-------------------------|------------------------|----------------------------|
| 1. Contactor            | 2. Sleeve stretch. arm | 3. Left clamps             |
| 4. Right clamps         | 5. Pump                | 6. Blowing motor           |
| 7. Steam solenoid valve | 8. Photocell           | 9. Super-heater resistance |

## 28. SUBSTITUTION OF POWER CURRENT FUSES

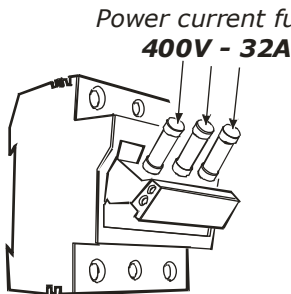

The power current fuses protect the whole machine and are situated near the electronic card. If the fuses of the electronic card have been checked and are not damaged, check the power current fuses and replace them if necessary. To gain access to the fuses the main switch must be on pos. "0" and the four screws are to be unscrewed from the panel. N.B.: SUBSTITUTE FUSES WITH INTERCHANGEABLE ONES AND WITH THE SAME PERFORMANCE.

## 29. COMPULSORY AND PERIODICAL MAINTENANCE

*(TO BE CARRIED OUT EXCLUSIVELY BY AUTHORIZED SERVICE CENTRES, QUALIFIED TECHNICIANS OR BY THE MANUFACTURER.)*

Compulsory maintenance is signalled by icon . Contact ONLY the reseller, Authorized Service Centres or the manufacturer in order to carry out the required maintenance/inspections. Once maintenance has been done the warning will be removed.

**30. PACKING, STORAGE, AND TRANSPORT**

ZEUS may be packed with cellophane, on a pallet or in a cardboard box which should never be turned upside down. As this is not a stiff package it is not shock-resistant and therefore the boxes should not be piled one on top of the other. We suggest you to handle the packed dummy with utmost care and not to use it as a stool or support. (Handle with care).

**31. DISPOSAL**



ZEUS is mainly made of iron material and must therefore be disposed of in proper warehouses for used iron recovery. The crossed rubbish bin symbol indicates that components of ZEUS must be disposed of separately from other refuse. The correct disposal and recycling of the machine's components assures protection of the natural environment.

.....;

**Every product manufactured by BATTISTELLA B.G. S.r.l. is subject to following limitations:**

- ❖ **Battistella B.G. S.r.l.** guarantees that this machine, correctly installed and used, works accordingly to this instruction handbook. Each implicit warranty is limited by law as from purchase date.
- ❖ **Declination of responsibility for consequential damages: Battistella B.G. S.r.l.** will never take the responsibility for any damage (included, without any limitation, consequential damages due to loss or no profit, cutback or any other economical loss) deriving from the use of a BATTISTELLA machine, even in case the Company had been previously informed of such kind of possibility.

Should you need **further information** about this handbook, please contact **Battistella B.G. S.r.l.** or the person who sold you the machine.

.....;