

 **texi**®

Culture of Sewing



strima.com



EN

CUTTING	6
INDUSTRIAL SEWING MACHINES	12
MACHINES FOR HEAVY MATERIALS	33
EMBROIDERY MACHINES	44
ACCESSORIES FOR INDUSTRIAL SEWING MACHINES	46
NEEDLES FOR INDUSTRIAL SEWING MACHINES	52
NEEDLES FOR HOUSEHOLD SEWING MACHINES	54
HOUSEHOLD SEWING MACHINES	60
HOUSEHOLD ACCESSORIES	82
PATCHWORK	98
IRONING	102
FASTENING	108

© Strima Sp. z o.o. All rights reserved.

We have made every effort to ensure that the information contained in this brochure is as accurate and up-to-date as possible. In line with our strategy of continuous product development, we reserve the right to modify their elements or change technical parameters without notice. No part of this publication may be reproduced in any form without the written permission of the publisher. The prospectus is for informational purposes only and does not constitute a commercial offer. Printed in Poland – April 2024.



Culture of Sewing



TEXI is a complete solution for fashion, upholstery or leather ateliers. For sewing enthusiasts we also offer our support and advice.

TEXI's product portfolio includes industrial sewing machines and home sewing machines, ironing devices, labeling and sewing accessories.

Founded in 2009 as an answer to customer demand for energy saving, silent and user-friendly machines. TEXI today is distributed in more than 100 countries all over the world. We are part of high-class fashion and promotional events such as Project Runway and Art and Fashion Forum for promising talents.



Cutting

texi.Titanium Scissors

- ✓ Blades surface hardened with titanium
- ✓ Maximum resistance
- ✓ Lifetime guarantee
- ✓ Soft grip



TI700

7" (18 cm) Titanium coated, professional dressmaker shears



TI914

9 1/4" (23,5 cm) Titanium coated, professional dressmaker shears



TI613 CRAFT

6 1/3" (16 cm) Titanium coated scissors for upholstery



TI514

5 1/4" (13 cm) Titanium coated hobby - craft scissors



TI814

8 1/4" (21 cm) Titanium coated, professional dressmaker scissors



TIDU0850

Ti 514 + Ti 814
Titanium coated dressmaker shears 8 1/4" (21 cm) and hobby - craft 5 1/4" (13 cm)

texi Titanium

Soft grip



CUTTING

texi Round knife cutters

TEXI ZORRO 100

Round knife with AC Servo motor

27 MM



- blade diameter 100 mm
- direct drive AC Servo motor
- 5-step speed regulation
- cutting height 27 mm
- LED lamp
- quiet operation
- lightweight 1,3 kg



LED lamp lighting of the cutting field

TEXI ZORRO 110 FREE

Cordless round knife with DC Servo motor

32 MM



BATTERY



PRICE & INFO

- blade diameter 110 mm
- direct drive DC Servo motor
- 5-step speed regulation
- cutting height 32 mm
- LED lamp
- quiet operation
- lightweight 1,5 kg



LED lamp - 3-step work field lighting

texi Cutting machines

TEXI SIRIUS-P 1390

CO₂ plotter for cutting and engraving. A laser device for cutting and marking fabrics, wood, plastic, plexiglass, rubber, glass and ceramics.



PRICE & INFO



CO ₂ laser power	130 W
Working area	1300 x 900 mm
Standard lens	2"
Cutting speed	0 - 600 mm/sek
Engraving speed	0 - 1060 mm/sek
Positioning accuracy	+/- 0,05 mm
Cooling	Water
Smoke extraction system	Turbine
Table type	Honeycomb and ribbed
Table height adjustment	Electronic
Control panel	3" LCD panel Motors: AC SERVO
Supported image file formats	PLT, AI, DXF, DST, BMP, JPG, etc.
Additional options	Rotary attachment, 3" lens (for cutting thicker materials materials)

TEXI XYZ 2517

Modern single-layer cutter with conveyor system designed for automatic cutting of fabrics, synthetic materials, technical fabrics, leather and other materials.



PRICE & INFO

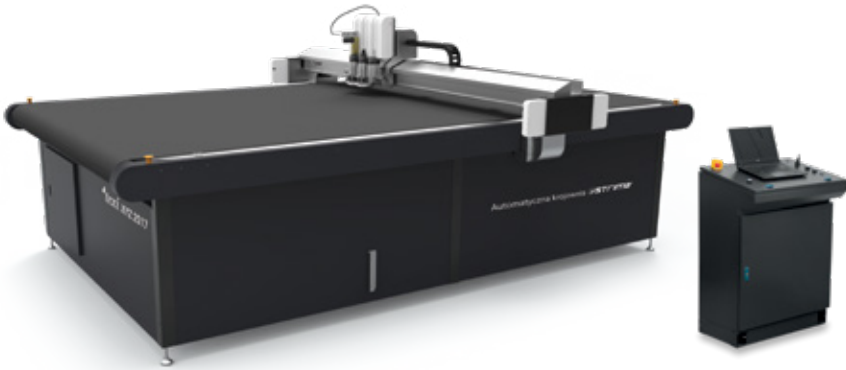



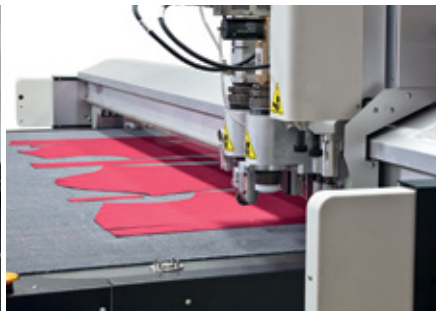





































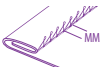

Working area	2 500 x 1 700 mm
Device dimensions	3 350 x 2 550 mm
The minimum width of the wall opening through which the device can be installed in the factory	2 600 mm with bridge / 2 150 mm without bridge
Width and length of the material feeder with motor	2 170 mm / 1 100 mm
Total length of the device with the installed feeder	5 520 mm + 600 mm computer / min. 6m
Maximum cutting speed	1500 mm/s
Cutting accuracy	to 0,1 mm
Maximum cutting thickness	to 50 mm
Engines	AC Servo
Turbine power	7,5 kW
Total device power	9 kW
Power supply	400 V, 3 phases
Software language	English
File handling	PLT/HPGL, DXF, PDF



texi Industrial sewing machines

KEY

AUTO		THREAD TRIMMER		BOTTOM ROLLER FEED AND ROLL PRESSER FOOT
		BARTACKING AUTOMATIC		NEEDLE SYSTEM
		WIPER		TOTAL NEEDLE GAUGE
		AUTOMATIC PRESSER FOOT LIFTER		SPLIT NEEDLES
		AUTOMATIC NEEDLE POSITIONING		PRESSER FOOT LIFT HEIGHT
		STARTING STITCH CONTROLLER		LED LAMP
		BOTTOM FEED		THICKNESS OF SEWN FABRIC
	NEEDLE FEED		SEWING SPEED	
	COMPOUND FEED - BOTTOM AND WALKING FOOT		BUILT-IN MOTOR	
	UNISON FEED		NO. OF THREAEDS	
	DIFFERENTIAL BOTTOM FEED			

	STITCH LENGTH		BUTTONHOLE SIZE
			CLAMP SIZE
			KNIFE SIZE
			SYSTEM MULTI-CUT
			BARTACK SIZE
		STITCH WIDTH	
			SEWING-IN POST BUTTON
			WORKONG AREA
			SKIP STITCH DEVICE
	NO. OF PATTERNS		POST HEIGHT
			POST CIRCUMFERENCE

texi 1-needle mechatronic lockstitch machines



BOTTOM FEED



PRICE & INFO

TEXI TRONIC 6 NEO

Lockstitch machine with bottom feed

	AUTO						
TEXI ART AUTO 2	✓	✓	-	✓	✓	✓	✓
TEXI TRONIC 3 NEO	✓	-	-	-	✓	-	✓
TEXI TRONIC 6 NEO	✓	✓	-	✓	✓	✓	✓
TEXI TRONIC 7 NF	✓	✓	✓	✓	✓	-	-

TEXI TRONIC 7 NF

Lockstitch machine with needle feed



PRICE & INFO



NEEDLE FEED



TEXI TRONIC 3 NEO

Lockstitch machine with thread cutting and bottom feed



PRICE & INFO



BOTTOM FEED



more next page

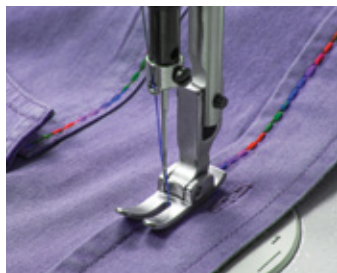

TEXI ART AUTO 2 PREMIUM

Automatic lockstitch machine with decorative stitch for light and medium fabrics, with built-in stepper motor and control

	 SYSTEM	 MM	 MM				 AC SERVO 230 V
-	135 x 5	5	13	✓	L/M	5 000	550 W
-	135 x 5	5	13	✓	L/M	5 000	550 W
-	135 x 5	5	13	✓	L/M	5 000	550 W
✓	135 x 5	4	13	✓	L/M	4 000	550 W



PRICE & INFO

Lockstitch machine with automa

TEXI TRONIC 3 NEO

Lockstitch machine with automatic thread cutting

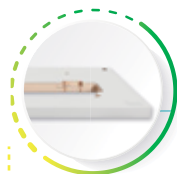

Table top PREMIUM Resistance

Table board (30 layers of birch plywood) covered with a laminate resistant to impacts, chips, abrasion, oil and moisture.



Solid base Kessler Stability

Stable and durable Kessler bases with adjustable height



ation at the best price on the market



LED lamp
A better view

It's always worth seeing more



AC SERVO MOTOR
Savings

You save up to 70% of energy



INDUSTRIAL SEWING MACHINES

texi 2-needle mechatronic lockstitch machines

TEXI TWIN MS

Two needle, lockstitch machine with needle feed and automatic needle positioning



PRICE & INFO



NEEDLE FEED



TWO NEEDLES



AUTO

-	-	-	-	PREMIUM EX	✓	135x5	6.4	✓	5	11	✓	L/M	3000	550 W	

PREMIUM



WARRANTY
PREMIUM

lower price



PREMIUM EX



EXTENDED WARRANTY
PREMIUM EX









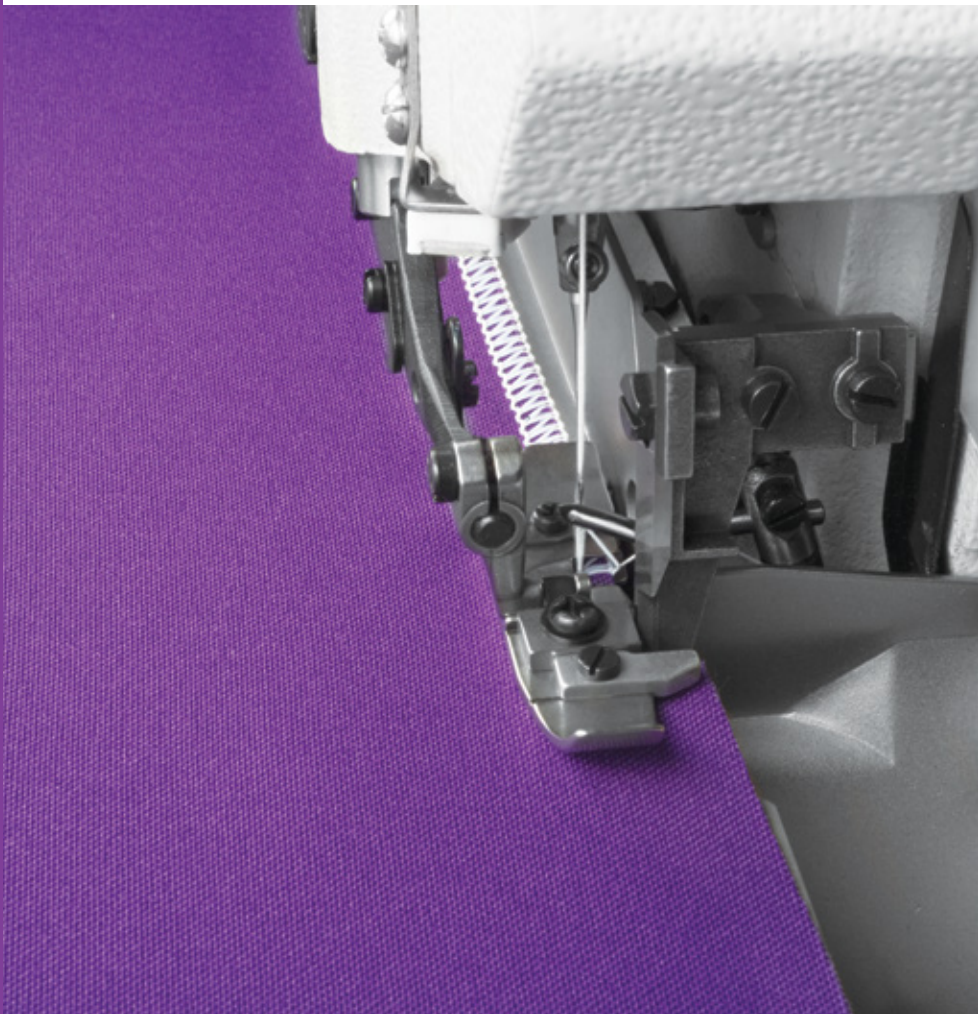

additional
equipment



EXTRAS
& EXTENDED INDUSTRIAL
WARRANTY

texi Overlock (safety stitch) machines



		AUTO								
										
16	TEXI TRE 04 N	-	-	-	-	✓	✓	1	B-27	-
17	TEXI QUATTRO 24 N	-	-	-	-	✓	✓	2	B-27	2
18	TEXI CINQUE 35 N	-	-	-	-	✓	✓	2	B-27	3

TEXI QUATTRO 24 N

4-thread, mechatronic overlock machine



PRICE & INFO

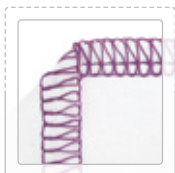

TEXI TRE 04 N

3-thread mechatronic overlock machine



PRICE & INFO



TEXI CINQUE 35 N

5-thread, mechatronic overlock machine











PRICE & INFO



3	4 mm	-	4 mm	6	✓	L/M	7 000	550 W
4	6 mm	-	4 mm	6	✓	L/M	7 000	550 W
5	5 mm	8 mm	4 mm	6	✓	L/M	7 000	550 W

texi Coverstitch (interlock) machines



	AUTO						
							
TEXI TRECCIA	-	-	-	-	✓	1:0.5 ~ 1:1.3	3
TEXI TRECCIA C MATIC	✓	-	✓	✓	✓	1:0.5 ~ 1:1.3	3

TEXI TRECCIA N

3-needle flat-bed interlock machine



PRICE & INFO



FLAT-BED



TEXI TRECCIA C MATIC

3-needle cylinder-bed interlock machine



PRICE & INFO



CYLINDER-BED



	SYSTEM	5.6 / 6.4	5	1.6~4.2 mm	6	✓	CYLINDER-BED	6 000	AC SERVO 230V
UY 128 GAS		5.6 / 6.4	5	1.6~4.2 mm	6	✓	-	6 000	550 W
UY 128 GAS		5.6 / 6.4	5	1.6~4.2 mm	6	✓	✓	6 000	550 W

texi. Specialized sewing machines

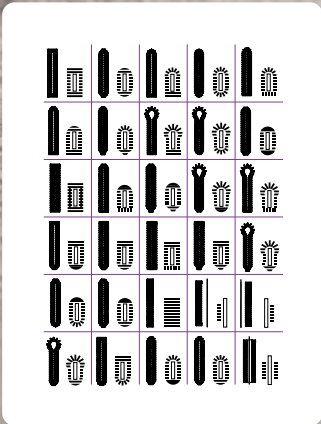

TEXI O NEO

Electronic buttonhole machine



PRICE & INFO



AUTO					SYSTEM	PATTERNS	MM	MM	MULTI CUT	MM			AC SERVO 230 V	
✓	-	-	✓	-	135 x 5	30	A = 9.4 - 41.0 B = 0.1 - 5.0	A = 29, B = 5 A = 40, B = 6	✓	14	✓	L/M	3 600	550 W

TEXI X

Electronic button sewing machine



PRICE & INFO



8, 16, 32



AUTO



SYSTEM



MM



Ø = 10~28



A: 2.5 - 6.5



OPTION



1 500



AC SERVO
230V

550 W

TEXI ZIGGY

Electronic zigzag machine with automatic functions



PRICE & INFO

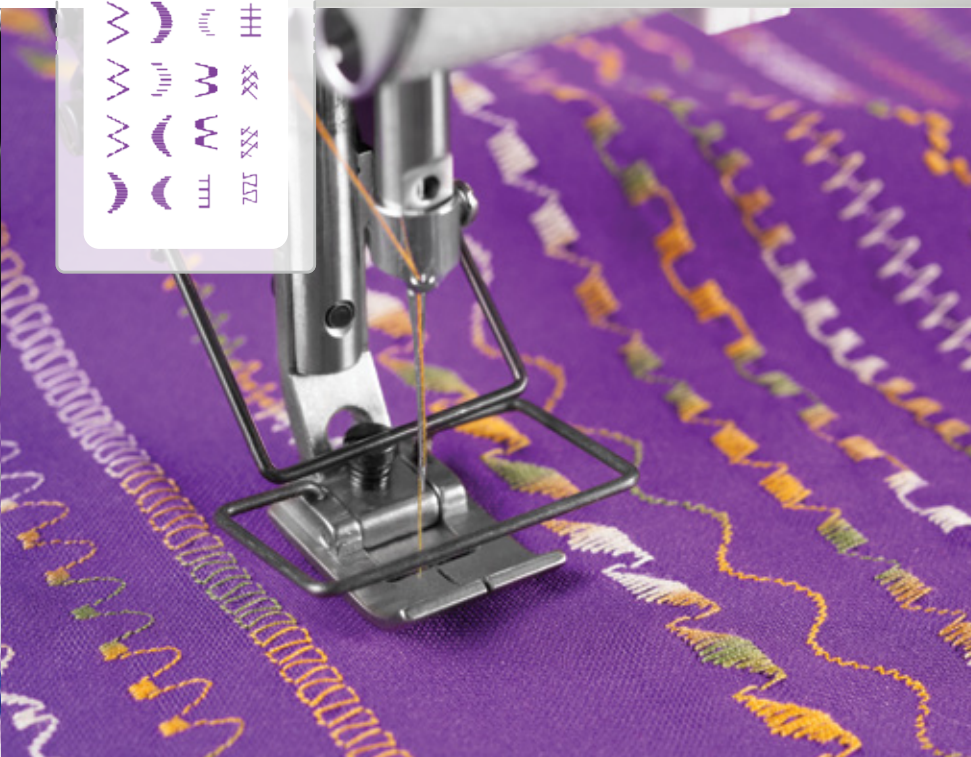

INDUSTRIAL SEWING MACHINES

AUTO														
✓	✓	✓	✓	✓	SYSTEM	CM	PATTERNS	MM	MM	MM	✓	L/M	5 000	550 W

TEXI ACCURA

Blind stitch machine for light and medium fabrics



PRICE & INFO



TEXI COMPACTA

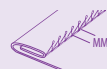

3.0 - 8.0



INTERVAL

1:1/1:2

TEXI ACCURA

3.0 - 8.0

1:1/1:2

TEXI COMPACTA

Portable blind stitch machine for light and medium fabrics



PORTABLE

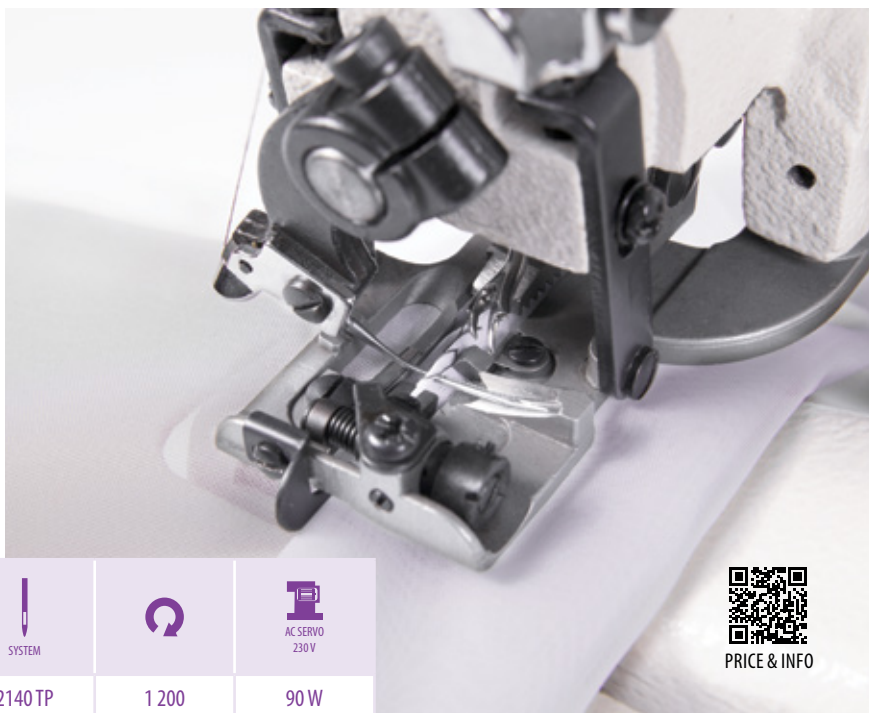
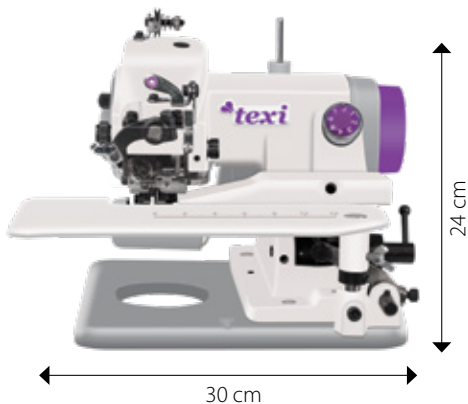

SYSTEM



AC SERVO
230 V

2140 TP

1 200

90 W

2140 TP

2 500

550 W



PRICE & INFO

TEXI SEP SYSTEM

Multifunctional machine for sewing, embroidering and perforating leather and coated fabrics



PRICE & INFO

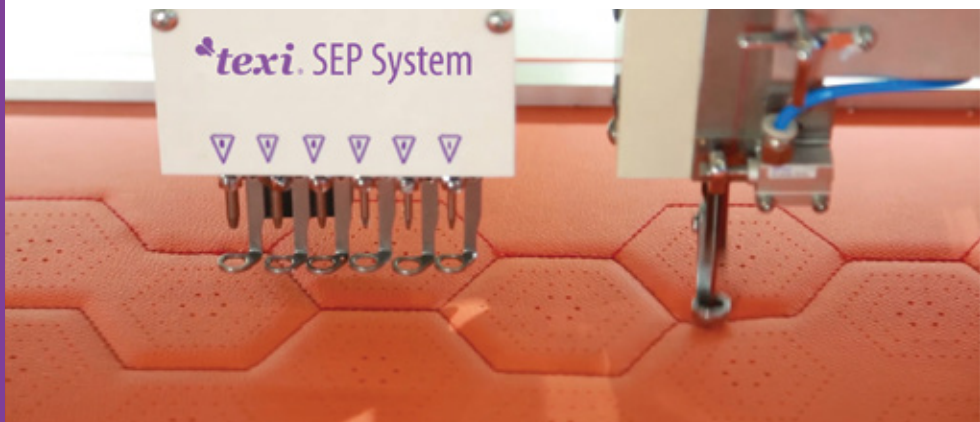

MODEL	TEXI SEP SYSTEM	TEXI SP SYSTEM	TEXI SP 360 SYSTEM
Working area	1 200 x 800 mm		
Bobbin/hook size	XXL / 26 mm		
Max. thread thickness	20		
Sewing	✓		
Sewing: number of needles	1		
Sewing: rotary head	–	–	✓ 360°
Sewing: lifting head	✓ 50 mm		
Max. sewing speed	1 000 stitches/min.	1 000 stitches/min.	1 200 stitches/min.
Feet lifting height	18 mm		
Max. stitch length	12,7 mm		
Embroidering	✓	–	–
Embroidering: number of needles	9	–	–
Max. embroidery speed	850 stitches/min.	–	–
Perforating	✓		
Perforating: number of knives	6		
Perforating: possible knives sizes	0,8 mm, 1,0 mm, 1,2 mm, 1,5 mm, 2,0 mm, 2,5 mm		
Max. speed perforation	800 holes/min.		
Automatic thread trimming	✓		
Broken thread sensor	✓		
Touch panel	✓		
Power supply	230 V or 380 V		
Total power	5,5 kW	5,1 kW	4,5 - 4,8 kW
Starting stitch controller	✓		
LED work area lighting	✓		
Compressed air	✓		

TEXI PERFO DUO

The computer-controlled perforating machine is a key tool for manufacturers of furniture, car upholstery and the clothing industry.



PRICE & INFO

WORKING AREA

TEXI PERFO DUO
= 1 200 x 800 mm

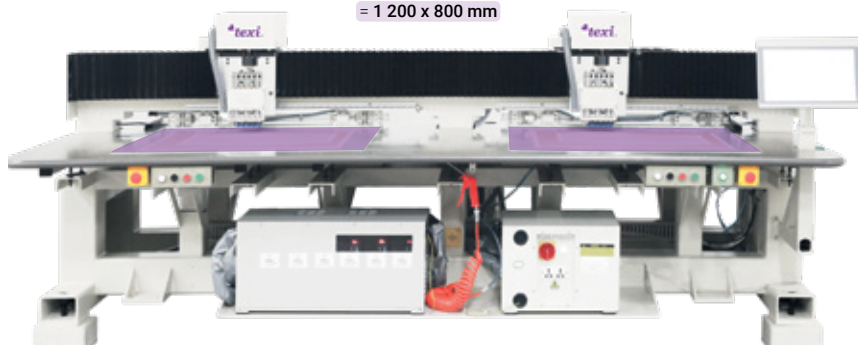

MODEL	TEXI PERFO 1200x800 DUO	TEXI PERFO 900x600 DUO
Working area	2 x 1200 x 800 mm	2 x 900 x 600 mm
Perforating		✓
Perforating: number of knives		6
Perforating: knife sizes included	0,8 mm, 1,0 mm, 1,2 mm, 1,5 mm, 2,0 mm, 2,5 mm	
Max. perforation speed	1 200 holes/min	
Touchpad		✓
Power supply	230 V	
Power	3 kW	
Starting stitch controller		✓
LED work area lighting		✓
Compressed air		✓

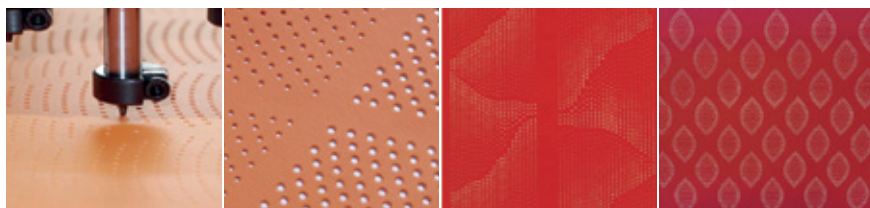

texi[®] Machines for heavy materials

TEXI FREE 360

Automatic sewing machine for sewing programmable patterns with a precise, rotating sewing head and three independent drives: head, hook and frame.



PRICE & INFO

WORKING AREA

TEXI FREE 360 LF 150X90 SET
= 1 500 x 900 mm

TEXI FREE 360 XLF 250X130 SET
= 2 500 x 1 300 mm

TEXI FREE 360 XXLF 250X150 SET
= 2 500 x 1 500 mm



LARGE WORKING AREA









MODEL	FREE 360 LF 150X90 SET	FREE 360 XLF 250X130 SET	FREE 360 XXLF 250X150 SET
Type of sewn fabric	Thick and difficult		
Working area	1 500 x 900 mm	2 500 x 1 300 mm	2 500 x 1 500 mm
Bobbin/hook size	XXL / 26 mm		
Max. thread thickness	20		
Automatic thread trimming	✓		
Thread breakage sensor	✓		
Touch panel	✓		
LED work area lighting	✓		
Max. sewing speed	3 000 stitch/min.		
Feet Lifting height	22 mm		
Max. stitch length	12,7 mm		
Needle system	135 x 17		
Power supply	230 V		
Rotary head 360	✓		
Engine power	750 W		
Compressed air	✓		

texi Walker Series

Upholstery and leather lockstitch machines



	AUTO				
					
TEXI WALKER WF SERVO	-	-	-	-	✓
TEXI WALKER WF AUT	✓	✓	✓	✓	✓

TEXI WALKER WF AUT
Automatic lockstich machine



PRICE & INFO

TEXI WALKER WF SERVO
Lockstich machine







AUTO



PRICE & INFO



MACHINES FOR HEAVY MATERIALS

	 SYSTEM	 MM	 CM	 MM				 AC SERVO 230 V
✓	135 x 17	8	33,5	16	✓	M/H	2 000	550 W
✓	135 x 17	8	33,5	16	✓	M/H	2 000	550 W

HD *texi*® FORTE Series

Upholstery and leather lockstitch machines







TEXI HD FORTE UF

Lockstitch machine
with unison feed



PRICE & INFO



	AUTO					
						
 TEXI HD FORTE UF	-	-	-	-	PREMIUM EX	✓
TEXI HD FORTE-B UF	-	-	-	-	PREMIUM EX	✓
TEXI HD FORTE CILINDRO UF	-	-	-	-	PREMIUM EX	✓
TEXI HD FORTE CILINDRO-B UF	-	-	-	-	PREMIUM EX	✓

TEXI HD FORTE-B UF
Lockstitch binding machine



PRICE & INFO



TRIPLE TRANSPORT



TEXI HD FORTE CILINDRO UF
Lockstitch cylinder-bed machine



PRICE & INFO



TRIPLE TRANSPORT



TEXI HD FORTE CILINDRO-B UF
Lockstitch cylinder-bed binding machine







PRICE & INFO



TRIPLE TRANSPORT



MACHINES FOR HEAVY MATERIALS

 SYSTEM	 CM	 MM	 MM		 AC SERVO 230 V	 CYLINDER-BED	 BINDING
134 - 35	26	8	14	2 800	750 W	-	-
134 - 35	26	8	14	2 800	750 W	-	✓
134 - 35	26	6	14	2 800	750 W	✓	-
134 - 35	26	6	14	2 800	750 W	✓	✓

1212 **texi** RAM Series



TEXI RAM B-T

Lockstitch machine with edge trimmer and binding device



PRICE & INFO



TEXI RAM R-A

Lockstitch machine with differential ruffling, for ruffled seams



PRICE & INFO

TEXI RAM TN

Twin-needle lockstitch machine



TWO NEEDLES



PRICE & INFO

	AUTO				TWO NEEDLES	MM	
TEXI RAM	-	-	-	✓	-	-	✓
TEXI RAM A	✓	✓	✓	✓	-	-	✓
TEXI RAM TN	-	-	-	✓	✓	12	✓
TEXI RAM B-T	-	-	-	✓	-	-	✓
TEXI RAM R-A	✓	✓	✓	✓	-	-	✓
TEXI RAM L-A	✓	✓	✓	✓	-	-	✓
TEXI RAM TN-L-A	✓	✓	✓	✓	✓	12	✓



TEXI RAM

Single-needle lockstitch machine



PRICE & INFO



TEXI RAM A

Automatic single-needle lockstitch machine



PRICE & INFO



TEXI RAM L-A

Single-needle lockstitch machine with an enlarged workspace



PRICE & INFO

TEXI RAM TN-L-A

Twin-needle lockstitch machine with an enlarged workspace



PRICE & INFO



TWO NEEDLES



WORK AREA
63,5 CM

SYSTEM	CM	MM	MM	MM	MM	AC SERVO 230V	
134 - 35	25,5	28	9	16	M/H	2 500	800 W
134 - 35	33,5	28	9	16	M/H	2 500	800 W
134 - 35	25,5	28	9	16	M/H	2 000	800 W
134 - 35	25,5	28	9	16	M/H	2 000	800 W
134 - 35	25,5	28	9	16	M/H	2 000	800 W
134 - 35	63,5	28	9	16	M/H	2 000	800 W
134 - 35	63,5	28	9	16	M/H	2 000	800 W



TWO NEEDLES

TEXI RAM TN-P

Post-bed twin-needle sewing machine



PRICE & INFO



TWO NEEDLES

TEXI RAM TN-P-A

Automatic post-bed twin-needle sewing machine



PRICE & INFO

	AUTO				TWO NEEDLES	SYSTEM	CM	MM	MM	MM			AC SERVO 230 V		
	Scissors	Stitch	Foot	Foot											
TEXI RAM TN-P	-	-	✓	-	✓	✓	134 - 35	16	26	9	16	✓	M/H	2 000	800 W
TEXI RAM TN-P-A	✓	✓	✓	✓	✓	✓	134 - 35	16	26	9	16	✓	M/H	2 000	800 W



TEXI RAM C

Single-needle cylinder bed sewing machine



PRICE & INFO



TEXI RAM C-A

Automatic single-needle cylinder bed sewing machine



PRICE & INFO

	AUTO				TWO NEEDLES	SYSTEM	CM	MM	MM	CYLINDER-BED			AC SERVO 230 V	
	Scissors	Stitch	Foot	Foot										
TEXI RAM C	-	-	-	✓	✓	✓	134 - 35	25,5	9	16	✓	M/H	2 500	800 W
TEXI RAM C-A	✓	✓	✓	✓	✓	✓	134 - 35	25,5	9	16	✓	M/H	2 500	800 W

TEXI POST DD PREMIUM

Post-bed lockstitch machine with bottom, needle and upper roller feed



PRICE & INFO



MACHINES FOR HEAVY MATERIALS

AUTO															
						SYSTEM	CM ↓								
✓	✓	-	-	✓	✓	135 x 5	17	21 mm	4.5	8	✓	M/H	3 000	750 W	AC SERVO 230 V

TEXI NOVA P-OS 3212









Automatic post bed double-needle sewing machine featuring decorative stitch



PRICE & INFO



TWO NEEDLES

	AUTO				 TWO NEEDLES	 MM	
							
TEXI NOVA 2609	✓	✓	✓	✓	-	-	✓
TEXI NOVA 3212	✓	✓	✓	✓	-	-	✓
TEXI NOVA TN 3212	✓	✓	✓	✓	✓	12	✓
TEXI NOVA P-OS 3212	-	✓	✓	✓	✓	8	✓

TEXI NOVA 2609

Single-needle automatic upholstery sewing machine. Large bobbin 26 mm



PRICE & INFO



XXL



TWO NEEDLES

TEXI NOVA 3212

Single-needle automatic upholstery sewing machine. Large bobbin 32 mm



PRICE & INFO

TEXI NOVA TN 3212

Twin-needle automatic upholstery sewing machine



PRICE & INFO

SYSTEM	MM	MM	CM	MM				AC SERVO 230 V
134 - 35	26	16	35,1	9	✓	M/H	3 400	800 W
134 - 35	32	16	35,1	12	✓	H/XH	3 400	800 W
134 - 35	32	16	35,1	12	✓	H/XH	3 400	800 W
134 - 35	32	16	35,5	12	✓	H	800	800 W

texi. Embroidery machines



TEXI 1501 XL TS

Industrial compact embroidery machine
15-needle

- Max. embroidery area 600 x 400 mm
- Sewing speed 1,000 stitches/min.
- Touch panel, WiFi connection
- 11 hoops (6 sizes)
- Hats, flat embroidery and more



PRICE & INFO

Operation training
and delivery included
in the price



PRICE & INFO

TEXI IRIS 12

Industrial compact
embroidery machine
12-needle

- Embroidery area
300 x 200 mm
- Sewing speed
1.000 stitches/min.
- Touch panel
- 4 hoops (4 different sizes)
- Hats, flat embroidery
and more

TEXI 4003

Pin for quick
foot fixing



PRICE & INFO

HIT!

TEXI 3 FEET

Turret for 3 presser feet for lockstitch machine



PRICE & INFO

TEXI 4026

Thread cutter



PRICE & INFO

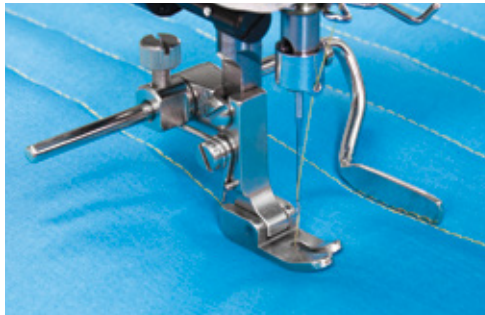
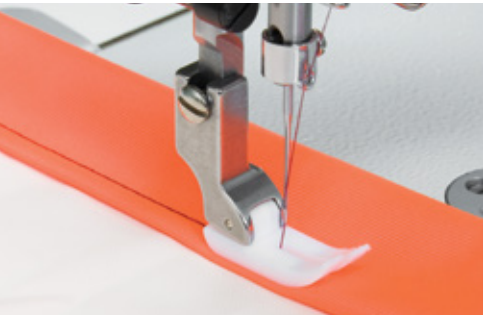
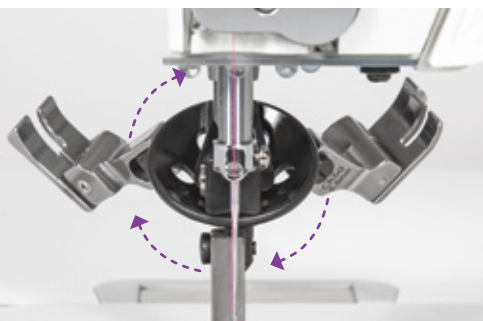

TEXI 5001

Foot for sewing leather and other difficult materials



PRICE & INFO

TEXI 5003

Foot with left and right gauges



PRICE & INFO

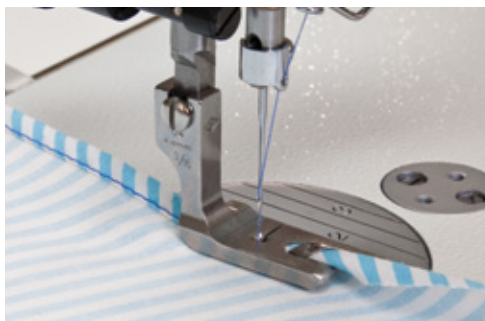

TEXI 5004

PTFE foot with rings



PRICE & INFO

TEXI 5006

Double hemming foot
1/8" (3.2 mm)



PRICE & INFO

1
2
3
4
5
6
7
8
9
10
11
12
13
14
15
16
17
18
19

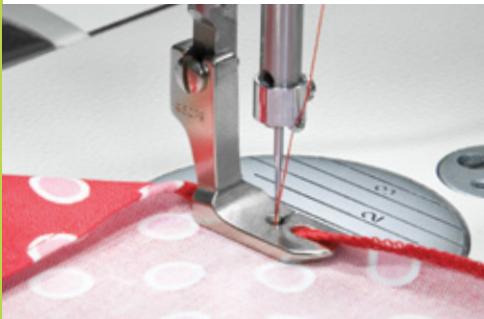

TEXI 5007

Single hemming foot
1/8" (3.2 mm)



PRICE & INFO



TEXI 5010

Adjustable
shirring foot



PRICE & INFO



Cording foot, narrow

TEXI 5008

Left



PRICE & INFO

TEXI 5009

Right



PRICE & INFO



TEXI 5011

Zipper foot



PRICE & INFO

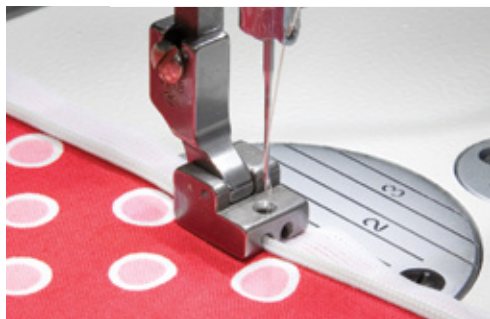

TEXI 5012

Invisible zipper
foot



PRICE & INFO

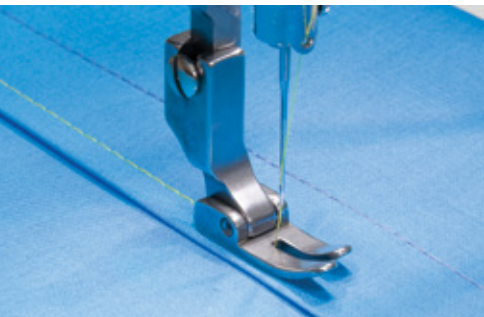

TEXI 5013
Standard foot



PRICE & INFO

TEXI 5014
Roller foot
for difficult fabrics



PRICE & INFO



TEXI 5015
Foot with central tape
guide 4.8 mm



PRICE & INFO

TEXI 5020
Piping foot
3.2 mm, left



PRICE & INFO



Compensating foot 1.0 mm

TEXI 5016
Right



PRICE & INFO

TEXI 5017
Left



PRICE & INFO

Compensting PTFE
coated foot, 1.0 mm

TEXI 5018

Right



PRICE & INFO

TEXI 5019

Left



PRICE & INFO

TEXI 5021

Foot for hemmer



PRICE & INFO

TEXI 5022

Foot for fine
fabrics



PRICE & INFO

TEXI 5023

Foot for heavy
fabrics



PRICE & INFO

TEXI 6001

Right angle
bias binder
30/8 mm



PRICE & INFO

8 mm



TEXI 6002

Tape binder
5/8" (16/8
mm)



PRICE & INFO



7,95 mm



TEXI 6003

Swing hemmer
3/8" (9.53 mm)



PRICE & INFO



9,53 mm

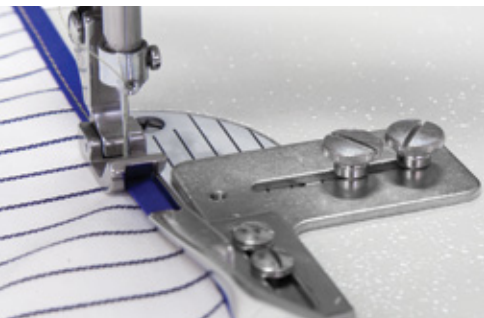

TEXI 4004

Universal screw for
binders, hemmers
and gauges (2 pcs)



PRICE & INFO



TEXI 4009

Magnetic
gauge



PRICE & INFO

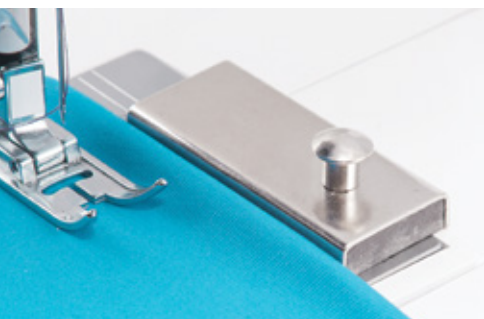

TEXI 4010

Magnetic gauge -
long (50 mm) and
very strong



PRICE & INFO



TEXI 4021

Sewing gauge



PRICE & INFO

texi Needles for industrial sewing machines



POINT TYPES FOR KNITTED AND WOVEN FABRICS

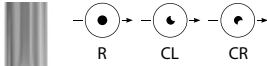

Normal round point

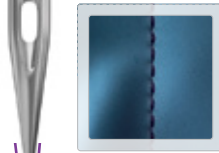
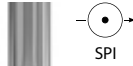

Acute round point



Light ball point

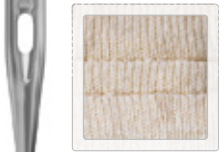

Medium ball point



Heavy ball point

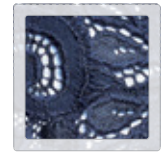

Special ball point

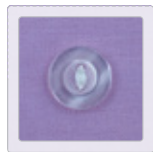

Heavy rounded point for sewing on buttons

POINT TYPES (BLADES) FOR LEATHER

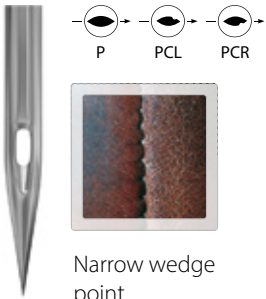

Narrow wedge point

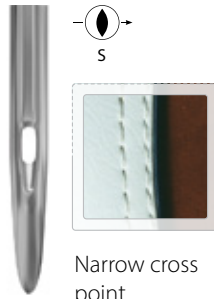

Narrow cross point

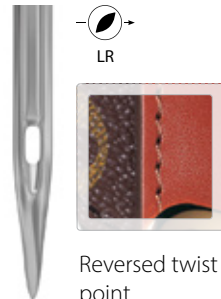

Reversed twist point

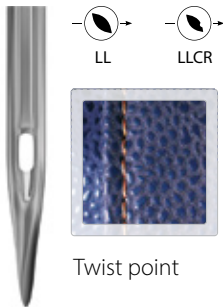

Twist point



Diamond point

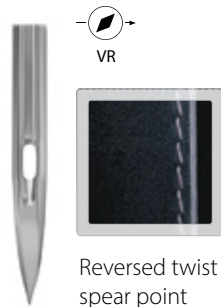

Reversed twist spear point

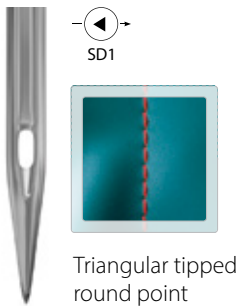

Triangular tipped round point

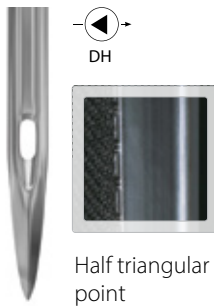

Half triangular point

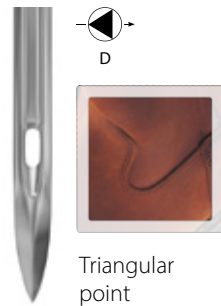

Triangular point

texi. Needles for household sewing machines

EASY WITH COLOR NEEDLE TYPE

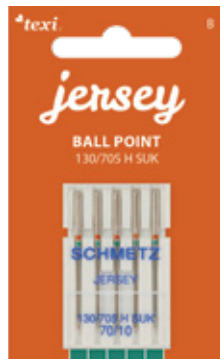
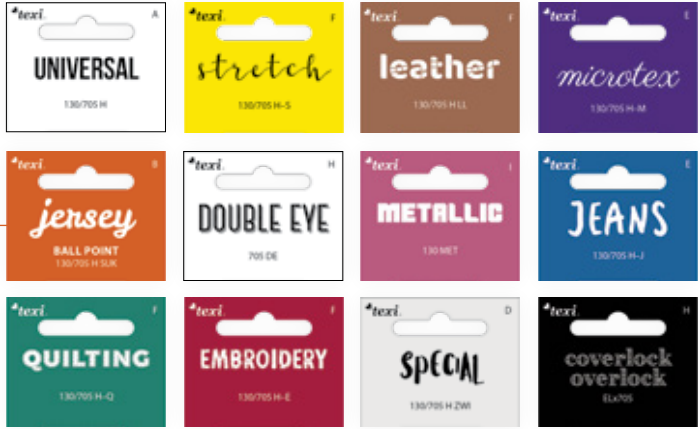

NEEDLE SIZE IN MM

TEXI JEANS

Jeans needle for tightly woven fabrics.



PRICE & INFO

	JEANS 130/705 H-J 5x70
	JEANS 130/705 H-J 5x80
	JEANS 130/705 H-J 5x90
	JEANS 130/705 H-J 5x100
	JEANS 130/705 H-J 5x110
	JEANS 130/705 H-J 2x90, 2x100, 1x110



TEXI LEATHER

Leather needle with cutting point for leather, imitation leather and similar fabrics. Not suitable for textiles.



PRICE & INFO

	LEATHER 130/705 H LL 5x70
	LEATHER 130/705 H LL 5x80
	LEATHER 130/705 H LL 5x90
	LEATHER 130/705 H LL 5x100
	LEATHER 130/705 H LL 5x110
	LEATHER 130/705 H LL 5x120
	LEATHER 130/705 H LL 2x80, 2x90, 1x100

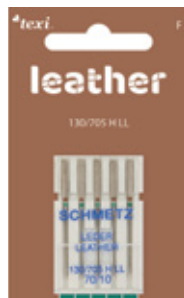

TEXI MICROTEx

Microtex needle for silk, microfibre fabrics, coated fabrics and foils.



PRICE & INFO

	MICROTEx 130/705 H-M 5x60
	MICROTEx 130/705 H-M 5x70
	MICROTEx 130/705 H-M 5x80
	MICROTEx 130/705 H-M 5x90
	MICROTEx 130/705 H-M 2x60, 2x70, 1x80



TEXI QUILTING

Special needle for quilting and patchwork.



PRICE & INFO

	QUILTING 130/705 H-Q 5x75
	QUILTING 130/705 H-Q 5x90
	QUILTING 130/705 H-Q 3x75, 2x90



TEXI EMBROIDERY

Special needle for embroidering with voluminous threads and woollen threads.



PRICE & INFO

- EMBROIDERY 130/705 H-E 5x75
- EMBROIDERY 130/705 H-E 5x90
- EMBROIDERY 130/705 H-E 3x75, 2x90

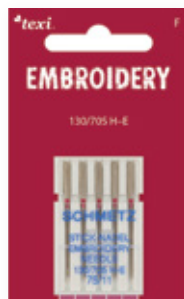

TEXI METALLIC

Metallic needle for trouble free sewing with sensitive metallic decorative threads.



PRICE & INFO

- METALLIC 130 MET 5x80
- METALLIC 130 MET 5x90



TEXI DOUBLE EYE

Double eye needle for topstitching with decorative threads.



PRICE & INFO

- DOUBLE EYE 705 DE 5x80



TEXI UNIVERSAL TWIN

Twin needle for decorative stitch.

Only for use on zig-zag-machines with transversal hook.



PRICE & INFO

- UNIVERSAL TWIN 130/705 H ZWI NE 2,0-80
- UNIVERSAL TWIN 130/705 H ZWI NE 2,5-80
- UNIVERSAL TWIN 130/705 H ZWI NE 3,0-90
- UNIVERSAL TWIN 130/705 H ZWI NE 4,0-80
- UNIVERSAL TWIN 130/705 H ZWI NE 4,0-90
- UNIVERSAL TWIN 130/705 H ZWI BR NE 6-100
- UNIVERSAL TWIN 130/705 H ZWI BR NE 8-100

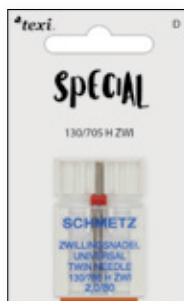

TEXI COVERLOCK OVERLOCK

Needle for overlock and coverlock machine.



PRICE & INFO



OVERLOCK/COVERLOCK ELX705 5x80
OVERLOCK/COVERLOCK ELX705 5x90
OVERLOCK/COVERLOCK ELX705 CF 5x65
OVERLOCK/COVERLOCK ELX705 CF 5x80
OVERLOCK/COVERLOCK ELX705 CF 5x90
OVERLOCK/COVERLOCK ELX705 SUK CF 5x65
OVERLOCK/COVERLOCK ELX705 SUK CF 5x80
OVERLOCK/COVERLOCK ELX705 SUK CF 5x90



TEXI CREATIVE 5

Needles for household machines MIX, 5 pcs



PRICE & INFO

TEXI CREATIVE 9+

Needles for household machines MIX, 9 pcs



PRICE & INFO

TEXI CREATIVE 10

Needles for household machines MIX, 10 pcs



PRICE & INFO

texi Household sewing machines



PRICE & INFO

TEXI JOY 13

Multifunctional sewing machine, 13 stitches



13 STITCHES

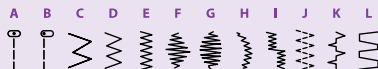

4 STEP
BUTTONHOLE

Extras inside



3 YEARS
WARRANTY

SAFE FOR
A CHILD

THE BEST
TO START

MAIN FUNCTIONS:

- 13 built-in stitches (including straight, zig-zag and decorative stitches)
- 4-step buttonhole
- Regulation of stitch length (max 3,6 mm) and width (max 4 mm)
- Backward sewing
- Maximum sewing speed 650 s.p.m
- Snap-on feet – SYSTEM MATIC
- Easy threading
- Free arm for circular sewing
- LED lamp
- Thread cutter
- Shuttle hook

EQUIPPED WITH:

standard foot, buttonhole foot, 2 bobbins, needle set, seam ripper, spool pin cap, oiler, soft cover



Free arm for circular sewing

enjoy
YOUR COLOR!



OPTION

TEXI JOY 13 EXTENSION TABLE

Table dimensions: 22,5 cm x 32 cm



PRICE & INFO



www.strima.com

TEXI GOLD

Multifunctional sewing machine, 24 stitches

NEW

3 YEARS WARRANTY

AUTO THREADING

EASY TO SEW THICK MATERIAL



PRICE & INFO



EQUIPPED WITH:

Set of 3 needles + double needle, multifunction screwdriver, bobbins (3pcs), embroiderer plate, seam ripper/brush, button foot, guide, zipper foot, buttonhole foot.

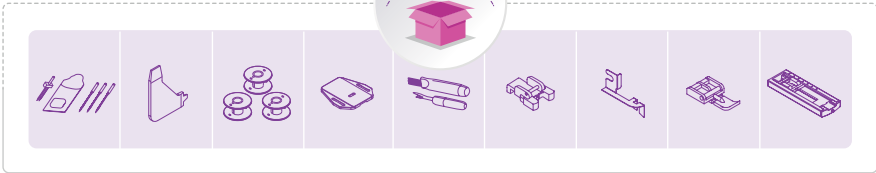

Gold | Servo Power

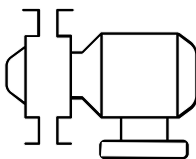

REVOLUTION IN SEWING MACHINES

Servo motor - more power and energy

MAIN FUNCTIONS:

- AC Servo motor
- 24 built-in stitches (including straight, zig-zag and decorative)
- 4-step buttonhole
- Regulation of stitch length (max. 3,6 mm) and width of zig-zag stitch type (max. 4 mm)
- Presser foot lifting height 5 mm
- Backwards sewing
- Maximum sewing speed 750 s.p.m.
- Snap-on feet - SYSTEM MATIC
- Free arm for circular sewing
- LED lamp
- Thread cutter
- Shuttle hook
- Needle threader



Free arm for circular sewing

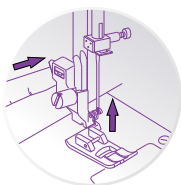

Contains a set of snap-on feet SYSTEM MATIC

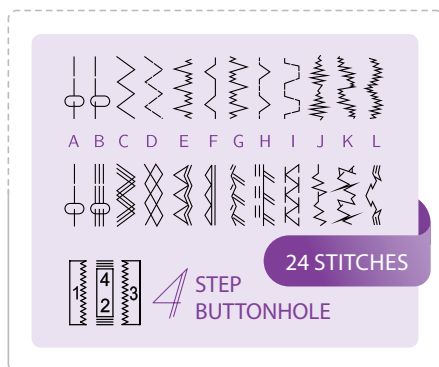

TEXI FOX 25

Multifunctional sewing machine, 25 stitches

3 YEARS WARRANTY



PRICE & INFO



EQUIPPED WITH:

standard foot, zipper foot, buttonhole foot, presser foot for sewing buttons, hem guide, 3 bobbins, needle set, seam ripper/brush, multifunction screwdriver, foot controller, oiler, soft cover.



MAIN FUNCTIONS:

- 25 built-in stitches (including straight, zig-zag and decorative)
- 4-step buttonhole
- Regulation of stitch length (max. 4 mm) and width of zig-zag stitch type (max. 4 mm)
- Presser foot lifting height 5,5 mm
- Backwards sewing
- Maximum sewing speed 700 s.p.m.
- Snap-on feet - SYSTEM MATIC
- Free arm for circular sewing
- LED lamp
- Thread cutter
- Shuttle hook
- Needle threader

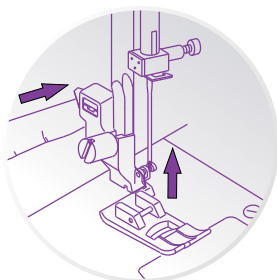
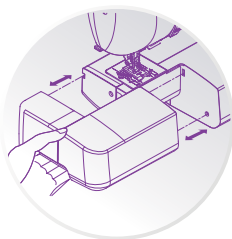
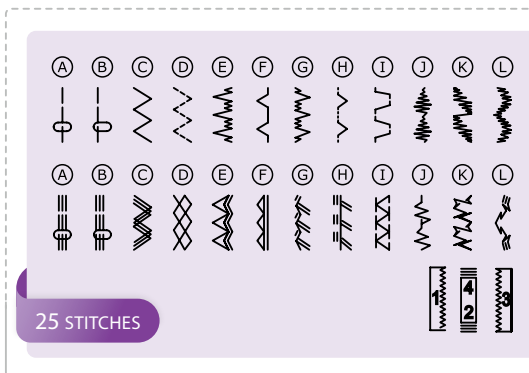

Contains a set of snap-on feet SYSTEM MATIC

REMEMBER ABOUT:

TEXI FOX 25 EXTENSION TABLE

Table enlarging the working area, dimensions: 36 cm x 26 cm.



PRICE & INFO



www.string.com

TEXI BRO

Multifunctional sewing machine, 24 stitches

NEW

3 YEARS
WARRANTY

AUTO
THREADING

EASY TO SEW
THICK
MATERIAL



PRICE & INFO

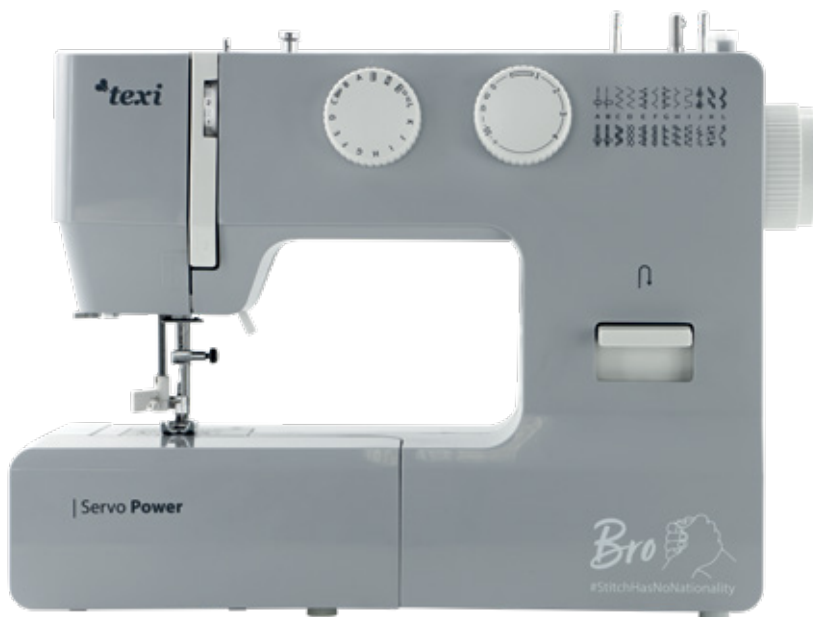

EQUIPPED WITH:

Set of 3 needles + double needle, multifunction screwdriver, bobbins (3pcs), embroiderer plate, seam ripper/brush, button foot, guide, zipper foot, buttonhole foot.

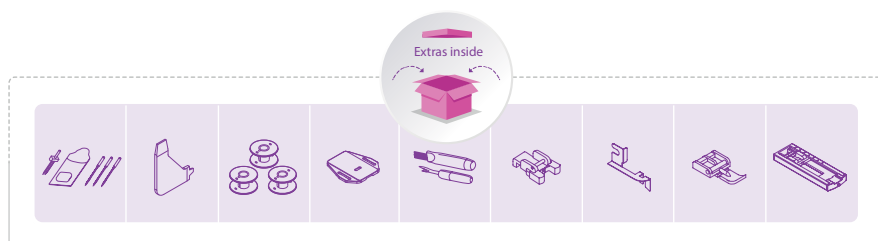

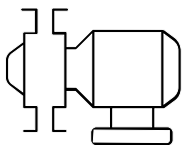

REVOLUTION IN SEWING MACHINES

Servo motor - more power and energy



MAIN FUNCTIONS:

- AC Servo motor
- 24 built-in stitches (including straight, zig-zag and decorative)
- 4-step buttonhole
- Regulation of stitch length (max. 3,6 mm) and width of zig-zag stitch type (max. 4 mm)
- Presser foot lifting height 5 mm
- Backwards sewing
- Maximum sewing speed 750 s.p.m.
- Snap-on feet - SYSTEM MATIC
- Free arm for circular sewing
- LED lamp
- Thread cutter
- Shuttle hook
- Needle threader



Video



Free arm for circular sewing

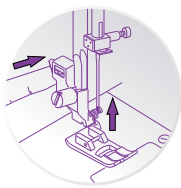

Contains a set of snap-on feet SYSTEM MATIC

24 STITCHES

4 STEP BUTTONHOLE

TEXI JOY 48

Multifunctional mechanical sewing machine, 48 stitches

3 YEARS WARRANTY



PRICE & INFO



EQUIPPED WITH:

Standard foot, zipper foot, buttonhole foot, embroidery plate, hem guide, 3 bobbins, needle set, seam ripper, brush, screwdriver, foot controller, oiler, soft cover

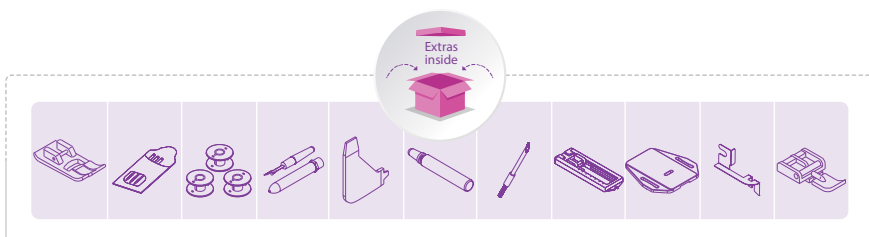

MAIN FUNCTIONS:

- 48 built-in stitches (including straight, zig-zag and decorative)
- 4-step buttonhole
- Regulation of stitch length (max 4 mm) and width (max 5 mm)
- Electronic stitch selection and regulation of stitch width
- Needle positioning button
- Presser foot lifting height 5,5 mm
- Backwards sewing
- Maximum sewing speed 700 s.p.m
- Snap-on feet – SYSTEM MATIC
- Free arm for circular sewing
- Lamp (LED)
- Thread cutter
- Shuttle hook



Free arm for circular sewing

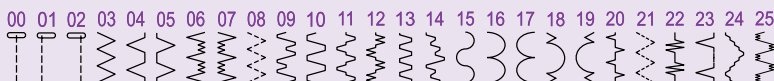
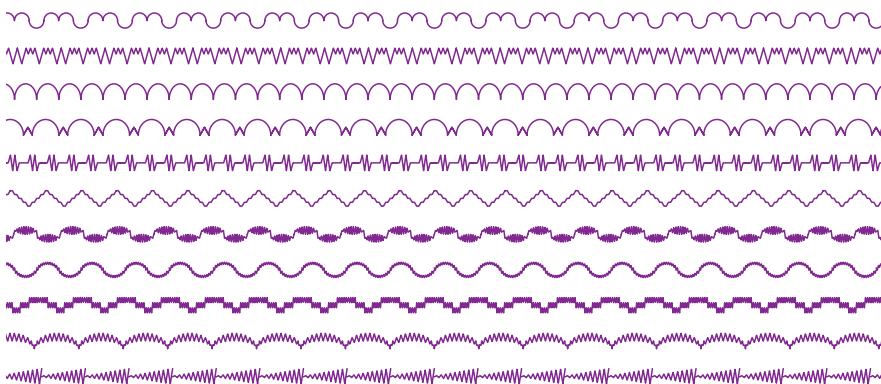

STEP
BUTTONHOLE

48 STITCHES

TEXI BLACK&WHITE

Multifunctional, computerized sewing machine

3 YEARS
WARRANTY

THE BEST EXTRAS
AS STANDARD

200
PROGRAMS



PRICE & INFO



Equipped with:

set of needles, double needle, bobbins, ripper/ Brush, screwdriver for needle plate, spool pin cap, small screwdriver, auxiliary spool pin, satin stitch foot, zipper foot, blind stitch foot, button foot, buttonhole foot, foot controller.



MAIN FUNCTIONS:

- 200 Sewing programs (including 9 types of buttonhole, straight, zig-zag, overlock and decorative stitches)
- Alphabet font
- Smooth regulation of stitch length (max. 4,5 Mm) and width (max. 7 mm)
- Backwards sewing
- Double needle sewing
- Maximum sewing speed 750 s.p.m.
- Electronic sewing speed regulation
- Lcd control panel
- Start/stop button
- Slow start button
- Needle positioning (top/bottom)
- Needle threader



free arm
for circular
sewing

- Snap-on feet - matic system
- Free arm for circular sewing
- Led lamp
- Rotary hook
- Metal componenets
- Drop feed lever

OPTION

TEXI BLACK&WHITE EXTENSION TABLE

Table dimensions: 42 cm x 29 cm



PRICE & INFO

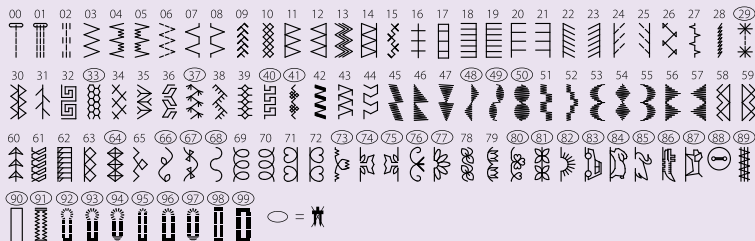

00 01 02 03 04 05 06 07 08 09 10 11 12 13 14 15 16 17 18 19 20 21 22 23 24 25 26 27 28 29 30 31 32 33 34 35 36 37 38 39 40 41
0 1 2 3 4 5 6 7 8 9 A B C D E F G H I J K L M N O P Q R S T U V W X Y Z a b c d e f
g h i j k l m n o p q r s t u v w x y z @ ! ? & □ ' " , . - / : ; A A E a a e e
 84 85 86 87 88 89 90 91 92 93 94 95 96 97 98 99
è é ç œ ì | ñ ñ ò ò ò ò ù ù

200 STITCHES



STANDARD
CYLINDER
XXL 50 x 38 cm

3 YEARS WARRANTY

THE BEST EXTRAS AS STANDARD

200 PROGRAMS

001	002	003	004	005	006	007	008	009	010	011	012	013	014	015	016	017	018	019	020	021	022	023	024	025	
026	027	028	029	030	031	032	033	034	035	036	037	038	039	040	041	042	043	044	045	046	047	048	049	050	
051	052	053	054	055	056	057	058	059	060	061	062	063	064	065	066	067	068	069	070	071	072	073	074	075	
076	077	078	079	080	081	082	083	084	085	086	087	088	089	090	091	092	093	094	095	096	097	098	099	100	
101	102	103	104	105	106	107	108	109	110	111	112	113	114	115	116	117	118	119	120	121	122	123	124	125	
126	127	128	129	130	131	132	133	134	135	136	137	138	139	140	141	142	143	144	145	146	147	148	149	150	
151	152	153	154	155	156	157	158	159	160	161	162	163	164	165	166	167	168	169	170	171	172	173	174	175	
U	V	W	X	Y	Z	,	?	&	a	b	c	d	e	f	g	h	i	j	k	l	m	n	o		
176	177	178	179	180	181	182	183	184	185	186	187	188	189	190	191	192	193	194	195	196	197	198	199	200	
p	q	r	s	t	u	v	w	x	y	z	[]	/	.	-	0	1	2	3	4	5	6	7	8	9

200 STITCHES

TEXI BALLERINA



REMEMBER ABOUT:

TEXI ENJOY SEWING MACHINE BAG

Bag for household sewing machine



PRICE & INFO



TEXI ENJOY MAXI SEWING MACHINE BAG

Bag for household sewing machine, large



PRICE & INFO



TEXI ENJOY OVERLOCK BAG

Bag for household overlock machine



PRICE & INFO



TEXI ENJOY MAXI OVERLOCK BAG

Bag for household overlock machine, large



PRICE & INFO



TEXI JOYLOCK

2, 3, 4-thread overlock machine for all types of materials



PRICE & INFO

3 YEARS WARRANTY



YOU'LL LOVE IT

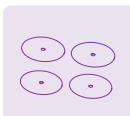

MAIN FUNCTIONS:

- 7 basic types of overlock stitches including rolled hem
- Differential feed ratio 0.7 – 2.0 mm
- Maximum sewing speed 1200 s.p.m.
- Stitch length 1 – 5 mm
- Stitch width up to 6 mm
- Presser foot lift up to 6 mm
- Adjustable presser foot pressure
- Mechanical integrated thread cutter
- Protection against machine start when looper threading ①
- Waste container ②

- Adjustable cutting width
- Deactivatable upper knife
- Color-coded threading system

EQUIPPED WITH:

lamp, 4 x spool pin cap, 4 x thread net, 4 x spool holder, tweezers, screwdriver x2, spanner, cleaning brush, machine oil, needle set, stitch finger, 2- thread converter, moving cutter, foot controller, soft cover, accessory bag



REMEMBER ABOUT:

TEXI 4079

A cleaning kit for each sewing machine



PRICE & INFO

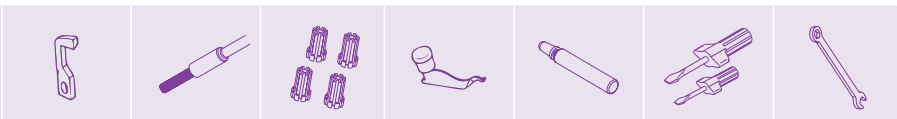

7 STITCHES

4-thread, safety stitch

3-thread, wide

3-thread, narrow

Rolled hem

Decorative overedge

3-thread overedge

4-thread overlock flatlock obverse

2-thread overlock flatlock reverse

TEXI 1050

5 feet set for Texi overlocks



PRICE & INFO



EASY TO THREAD

- Lower looper
- Upper looper
- Right needle
- Left needle

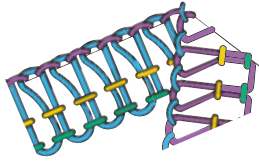

WIDE OPENING
FULL ACCESS
TO THE LOWER
LOOPERS

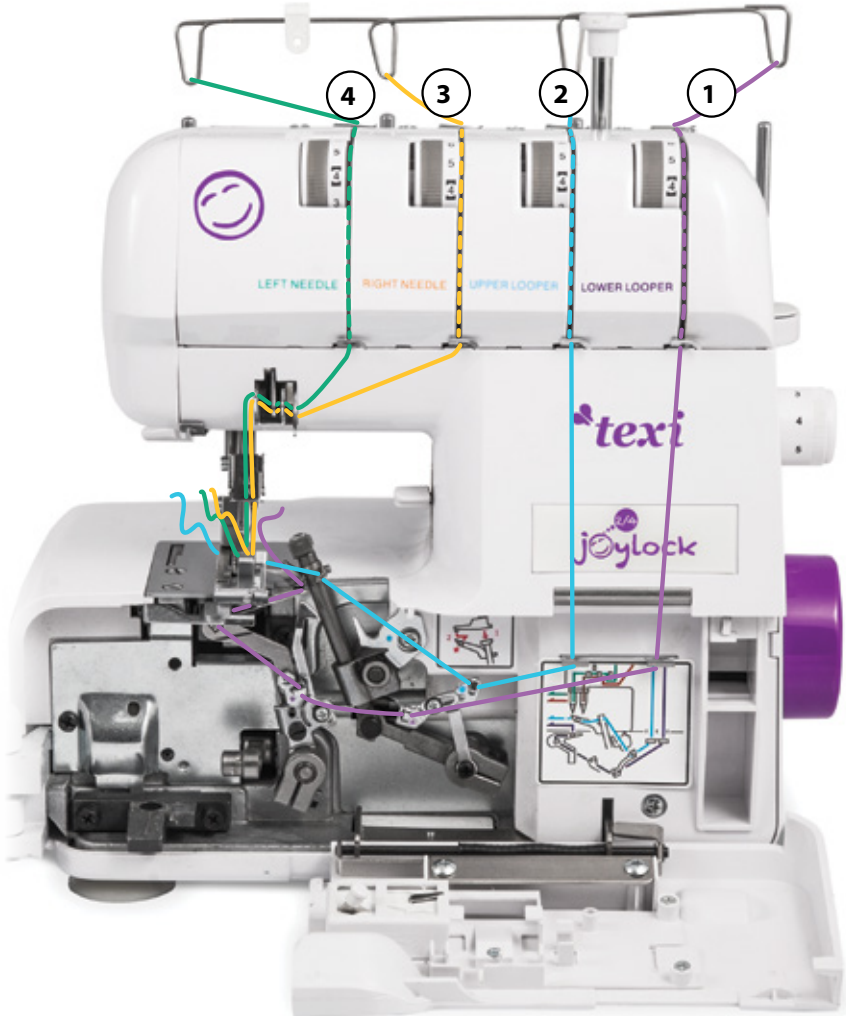

TEXI TEGRA

2, 3, 4-thread overlock machine for all types of materials



PRICE & INFO

3 YEARS WARRANTY



Free arm for circular sewing

EQUIPPED WITH:

needles - 3 pcs, spool disc, lower knife, guide bar, brush, tweezers, screwdriver (s), screwdriver (m), screwdriver (l), two-thread convertor.

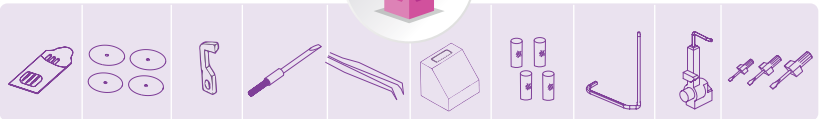

13 STITCHES

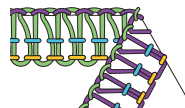

4-thread overlock

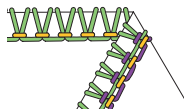

3-thread overlock,
wide

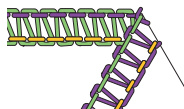

3-thread overlock,
narrow

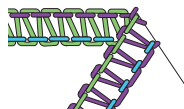

overlock hemming,
3-thread wide

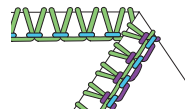

overlock hemming,
3-thread narrow

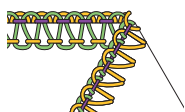

3-threaded
decorative

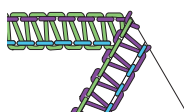

3-thread creased

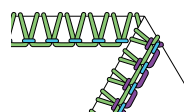

3-thread creased,
overlock



2-thread overlock,
wide



2-thread overlock,
narrow

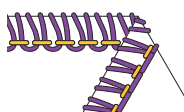

overlock 2-thread,
wide

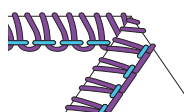

overlock 2-thread,
wide hemstitch

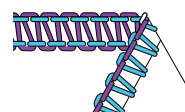

2-thread creased,
hemstitch

MAIN FUNCTIONS:

- Number of threads: 2, 3 or 4 threads
- Overedge stitch width: 6,7 mm
- Needle: HA1-SP
- HA x1(130/705H) / 12 / 80
- Stitch length: 1-4 mm
- Stitching speed: up to 1200 stitches per minute
- Presser foot lift: up to 4 mm
- Differential feed ratio: 0.7 – 2.0
- Dimensions: 360 mm (w) x 380 mm (l) x 380 mm (h)
- Weight 9,2 kg
- Adjustable presser foot pressure
- Manual thread cutter
- Waste container
- Protection against machine start when looper threading
- Adjustable cutting width
- Deactivatable upper knife
- Color-coded threading system
- LED lamp
- Tension release mechanism for easy thread pulling
- Free arm for circular sewing

texi Household accessories



TEXI SESAME DUO

Folding cabinet for 2 sewing machines

A tailor's workshop in one closet?

Markers, scissors, rulers, buttonhole cutters, pins, needles, thread, tweezers, bobbins, feet, wires and other sewing accessories in one place. And most importantly - machine and overlock too. You push on the board and the sewing machine appears from under the work table as if by magic, and with one movement of your hand you slide out the shelf with the overlocker. When you're done, close it three times and you've got everything organized in a locked cabinet.



Video



Dress form



Adjustment range	36 - 42	42 - 48
neck	35 - 46 cm	35 - 46 cm
bust	84 - 100 cm	101 - 117 cm
waist	64 - 80 cm	77 - 97 cm
hip	86 - 102 cm	102 - 119 cm



PRICE & INFO

TEXI DRESS FORM 36-42

TEXI DRESS FORM 42-48



texi. Accessories for household sewing machines

TEXI 0008

Invisible zipper foot, high fastening type



PRICE & INFO



TEXI 0009

Embroidery foot



PRICE & INFO



TEXI 0010

Sewing and shirring foot



PRICE & INFO

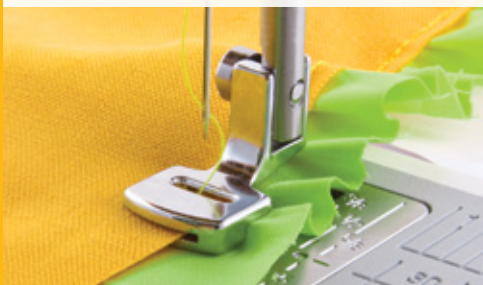

TEXI 0011

Shirring foot



PRICE & INFO



TEXI 0012

Application foot



PRICE & INFO

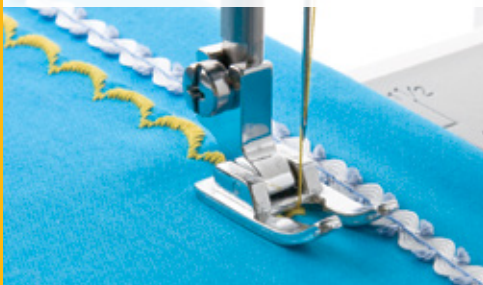

TEXI 0013

Roller foot for difficult fabrics



PRICE & INFO



TEXI 0014

Foot for piecing together two materials close to their edge



PRICE & INFO



TEXI 0019

Double-sided, wide, zipper and cording foot



PRICE & INFO



Double-sided, narrow zipper foot for household machine

TEXI 0017

Low fastening type



PRICE & INFO

TEXI 0018

High fastening type



PRICE & INFO

TEXI 0022

Ruffler



PRICE & INFO



TEXI 0023

Flower stitch foot



PRICE & INFO



TEXI 0024
Even feed foot



PRICE & INFO



TEXI 0025
Overlock foot
with trimmer



PRICE & INFO



TEXI 0026
Cord sewing foot



PRICE & INFO

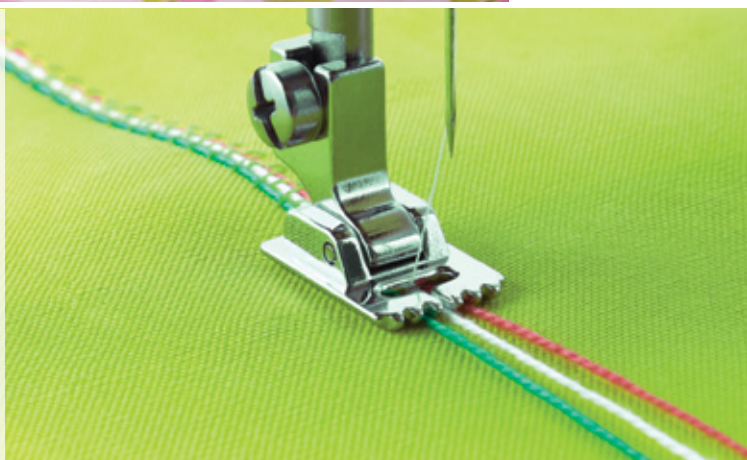

SYSTEM MATIC

Check what holder you have in your machine. Measure the height, from the bottom of the foot, to the screw that secures the handle to the needle bar. If the distance is about 1.5 cm, it means that we have a low type of foot mounting in our machine. The vast majority of household machines have this type of handle. If the distance from the bottom of the mounted foot to the screw is approximately 2.5 cm, it is a high foot mount.



MATIC

SYSTEM MATIC
presser foot holder

TEXI 1001

Low fastening type
(holder height 1.5 cm)



TEXI 1002

High fastening type
(holder height 2.5 cm)



TEXI 1003

MATIC universal foot



PRICE & INFO

TEXI 1004

MATIC universal foot,
plastic



PRICE & INFO

MATIC

TEXI 1005

MATIC sliding
buttonhole foot



PRICE & INFO

TEXI 1006

MATIC
application foot



PRICE & INFO

TEXI 1008

MATIC button foot



PRICE & INFO

TEXI 1009

MATIC double-sided zipper foot



PRICE & INFO

TEXI 1010MATIC double hemming foot
1/16" (1.6 mm)

PRICE & INFO

TEXI 1011

MATIC adjustable guide foot



PRICE & INFO

TEXI 1012

MATIC cording foot



PRICE & INFO

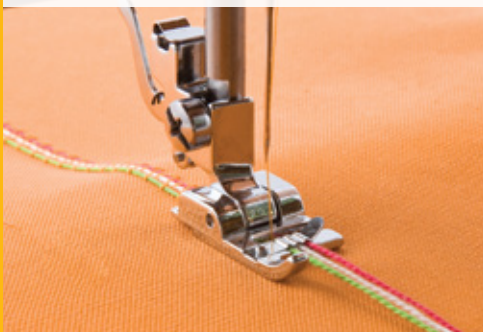

TEXI 1013

MATIC overcast
guide foot



PRICE & INFO

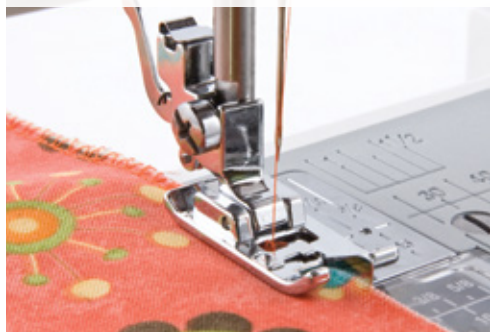

TEXI 1014

MATIC quilter's guide



PRICE & INFO



TEXI 1015

MATIC invisible
zipper foot



PRICE & INFO

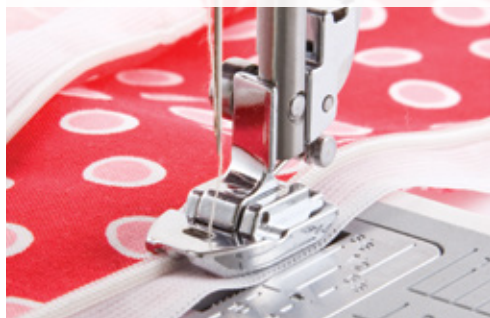

TEXI 1016

MATIC roller foot for
difficult fabrics



PRICE & INFO



TEXI 1017

MATIC bin justable
5-20 mm



PRICE & INFO





TEXI 2001

Binders and
hemmers fastening
handle



PRICE & INFO

BINDING

PIPING

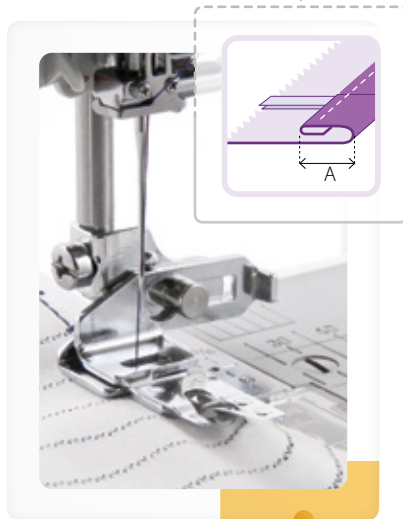

TEXI 2002

A = 7/32" (5,5 mm)

TEXI 2003

A = 1/10" (2,5 mm)

TEXI 2004

A = 1/4" (6,4 mm)

TEXI 2005

A = 3/8" (9,5 mm)

TEXI 2006

A = 5/8" (16 mm)

TEXI 2007

A = 7/8" (22 mm)

Texi Universal Accessories



TEXI 3003 SET 3

Bobbin
(metal, flat)
3 pcs



PRICE & INFO



TEXI 3004 SET 3

Bobbin
(plastic, flat)
3 pcs



PRICE & INFO



TEXI 3010 SET 3

Bobbin
(plastic, convex)
3 pcs



PRICE & INFO



TEXI 4005

Tweezers



PRICE & INFO



TEXI 4033

Storage box for 25
bobbins



PRICE & INFO



TEXI 4079

Set for cleaning the
machine



PRICE & INFO

TEXI 4047

Loop turner



PRICE & INFO

TEXI 4083

Button hole cutting knife



PRICE & INFO

TEXI 4049

Knit picker



PRICE & INFO

TEXI 4048

Finger presser tool



PRICE & INFO



TEXI 4013

Pencil
for fabrics:
white + color



PRICE & INFO



TEXI 4014

Disappearing pen
violet - pink



PRICE & INFO



TEXI 4015

Disappearing
pen



PRICE & INFO



TEXI 4016

Eraser for
disappearing
pen



PRICE & INFO



TEXI 4040

Tailor chalk pen with applicator



PRICE & INFO



TEXI 4041

Refill for pen
with applicator



PRICE & INFO



TEXI 4075

Flower head steel pins,
nickel plated
0.6 x 48 mm,
box of 80 pcs.



PRICE & INFO



TEXI 4076

Steel pins, nickle plated
0.6 x 48 mm,
box of 75 pcs.



PRICE & INFO

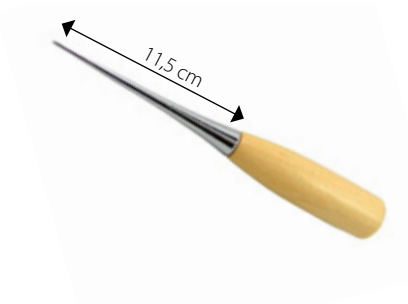

TEXI 4046

Tailor's awl for piercing holes
for rivets, snaps, eyelets



PRICE & INFO



TEXI 4082

Needle threader



PRICE & INFO



TEXI 4029

Magnetic pin and
needle holder



PRICE & INFO

TEXI 4034

Seam ripper



PRICE & INFO





TEXI 4080

A set of smart accessories for every seamstress



PRICE & INFO

TEXI 4011

Brush for naps lifting



PRICE & INFO

TEXI BOX 15

Set of thread 15 colors, household machine needles and leaflet



PRICE & INFO

TEXI 4006

Cleaning roll with handle
(1 roll = 10 mts)



PRICE & INFO

TEXI 4006R

Spare roll, tape lenght
10 mts



TEXI 4035

Tape makers set:
TEXI 4036 + TEXI 4037 + TEXI 4038



PRICE & INFO



TEXI 4036

A = 24 mm
B = 12 mm



TEXI 4037

A = 36 mm
B = 18 mm



TEXI 4038

A = 50 mm
B = 25 mm



TEXI 4020

Iron foot cleaning stick



PRICE & INFO



TEXI 4001

PTFE anti-shine



PRICE & INFO



TEXI 4002

Thermal adhesive powder



PRICE & INFO

texi. Craft Patchwork

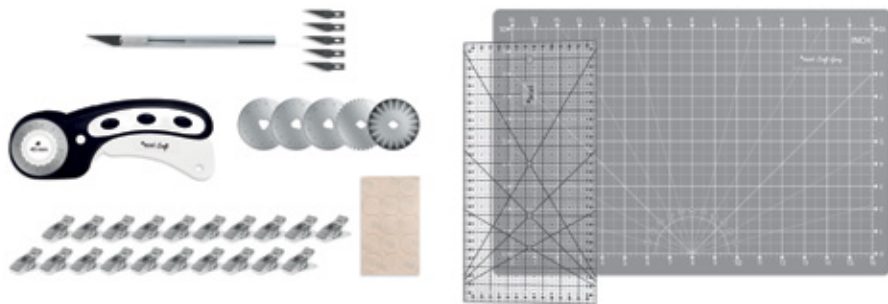

TEXI CRAFT GRAY 45 X 30

Set includes: rotary cutter 45 mm, self-healing mat, spare blades, ruler, craft knife with additional blades, fabric clips and anti-slip stickers



PRICE & INFO

Sets in different colors



**TEXI CRAFT
PINK 60 X 45 SET**

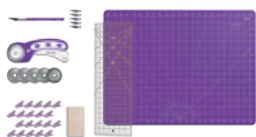

**TEXI CRAFT
PURPLE 60 X 45 SET**

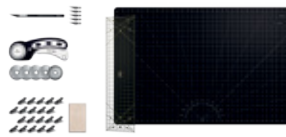

**TEXI CRAFT
BLACK 90 X 60 SET**

Rulers for patchwork and quilting

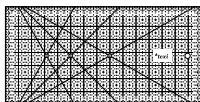

15 x 30 cm, black

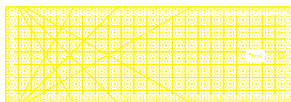

15 x 45 cm, yellow

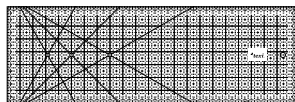

15 x 45 cm, black

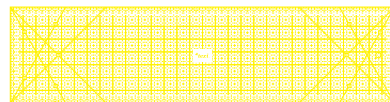

15 x 60 cm, yellow

TEXI 4097

Sewing clips 20 pcs
38 x 11 x 15 mm,
color mix



PRICE & INFO

TEXI 4106

Rotary cutter,
Ø45 mm



PRICE & INFO

TEXI 4107

Craft knife



PRICE & INFO

Which blade do you need?? Straight, curved, wavy?

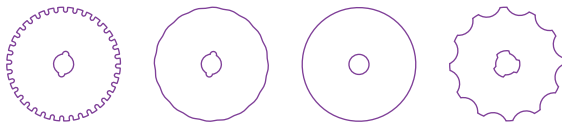

PRICE & INFO

Cutting
mat



PRICE & INFO

TEXI GRAY

45 x 30 cm
60 x 45 cm
90 x 60 cm

TEXI PINK

45 x 30 cm
60 x 45 cm
90 x 60 cm

TEXI BLUE

45 x 30 cm
60 x 45 cm
90 x 60 cm

TEXI BLACK

45 x 30 cm
60 x 45 cm
90 x 60 cm

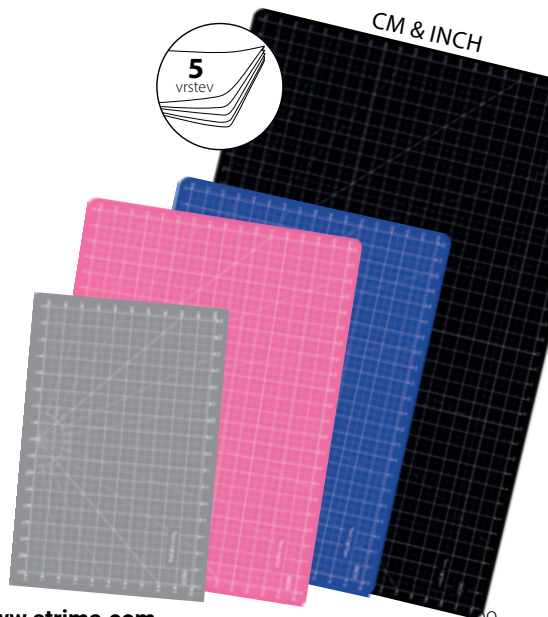

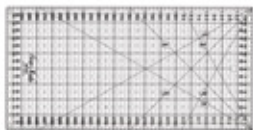

TEXI 4065

Quilting ruler, metric scale,
160 x 320 mm, black



PRICE & INFO

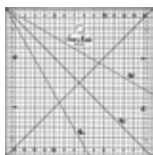

TEXI 4066

Quilting ruler, metric scale,
160 x 160 mm, black



PRICE & INFO



TEXI 4067

Quilting ruler, metric scale,
160 x 320 mm, yellow



PRICE & INFO

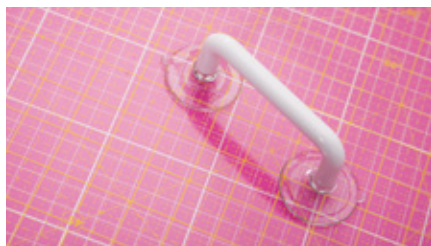

TEXI 4068

Ruler handle - 2 caps



PRICE & INFO



TEXI 4069

Ruler handle - 1 cap



PRICE & INFO



TEXI 4007

Tailor's tape measure,
length 150 cm,
width 19 mm



PRICE & INFO



TEXI 4008

Rollfix textile tape measure
- reversible 150 cm



PRICE & INFO



PRICE & INFO



texi Rotary Cutters



TEXI 4050
∅ 18 mm



TEXI 4051
∅ 28 mm



TEXI 4053
∅ 45 mm



TEXI 4054
∅ 60 mm

ROTARY CUTTER BLADES



straight



skip



wave

∅ 18 mm

∅ 28 mm

∅ 45 mm

∅ 60 mm

TEXI 4055

TEXI 4056
TEXI 4058
TEXI 4059

TEXI 4057

TEXI 4060



MODEL	SURFACE	HEIGHT ADJUSTMENT	BOARD POWER	IRON POWER	VACUUM	BLOWING	STEAM GENERATOR POWER	ONE FINGER OPERATION	SLEEVE BUCK
TEXI BIB	40 x 120 cm	81 - 100 cm	-	-	-	-	-	-	-
TEXI CHAMPION SB	45 x 120 cm	85 - 102 cm	400 W	-	35 W	35 W	-	-	-
TEXI SMART S+B	45 x 120 cm	60 - 105 cm	200 W	800 W	40 W	40 W	1 300 W	✓	✓

TEXI SLEEVE BUCK

Universal ironing sleeve buck,
52 cm long



PRICE & INFO



TEXI BIB

Iron table,
chromium-plated,
40 x 120 cm



PRICE & INFO



Heating



Suction



Blowing



85 - 102 cm



PRICE & INFO

TEXI CHAMPION SB

Ironing table board type
45 x 120 cm, with suction,
blowing and heated surface

TEXI SMART S+B

Compact ironing table with automatic, integrated steam generator and iron, PTFE shoe for iron and bottle for filling steam generator tank for FREE



PRICE & INFO



TEXI 1081



TEXI SMART S+B BRUSH



texi Heat presses



TEXI FLAT HEAT PRESS 40X60

Working area
40 x 60 cm



TEXI FLAT HEAT PRESS 38X38

Working area
38 x 38 cm



TEXI MUG HEAT PRESS

Compatible
with 17 oz cups



TEXI CAP HEAT PRESS

Working area
10 x 20 cm

texi Steam presses

HOME ATELIER LAUNDRY HOTEL



DIGITAL CONTROL



Electronically controlled ironing presses

TEXI APOLLO 68

Ironing surface 66 x 26 cm, 1600 W

TEXI APOLLO 101

Ironing surface 99 x 29 cm, 2200 W



PRICE & INFO

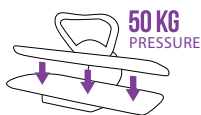

Force of 18 irons

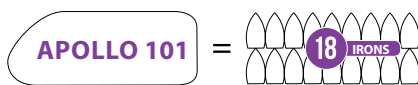

TEXI AP01

Stand for the Apollo ironing press, height 93 cm



PRICE & INFO



TEXI AP02

Telescopic stand for apollo ironing press height 63 - 73 cm



PRICE & INFO



texi *Black Turbo*

HIGH-PRESSURE STEAMER



PRICE & INFO

Clothes
Textiles
Upholstered furniture
Carpets

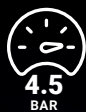

An incredible
pressure



Fast
start time



155°C

Steam
temperature



Easy
to move



Heated plate
function



For allergy
sufferers

IDEAL FOR PROFESSIONALS

For ironing and refreshing dresses, coats, suits and decorative items, including curtains and carpets. Texi Black Turbo will also work well for artificial fur and upholstered furniture. It is an invaluable asset in a tailor's shop, hotel, laundry or clothing boutique. It is be perfect in the catering business for ironing tablecloths and textiles.

FUNCTIONALITY AND DESIGN

Ergonomically arranged buttons and elements facilitate intuitive use of the device. The Texi steamer and its robust design feature high-quality materials and careful finishing. It was designed for ease of use and an elegant appearance that will look good in any space. It is also equipped with wheels that allow it to be easily moved, making it also suitable for use in mobile services such as events and outdoor weddings.

IDEAL SOLUTION FOR THOSE WHO SUFFER FROM ALLERGIES

Thanks to the sanitizing properties of high-temperature steam the Texi Black Turbo removes allergens, fungi, bacteria, and pollen from fabrics and textiles, thus helping to maintain a clean and healthy environment and reduce allergy-related discomfort.



RICH EQUIPMENT



Hanger



Attachment
for cuffs



Attachment
for collars



Fabric protector
for delicate
fabrics



Brush pad
for pile fabrics



Glove

In the Texi Black Turbo set you'll find attachments for ironing collars, trouser hems and suit lapels. It also has a special brush for refreshing plush fabrics, carpets and upholstered furniture. In addition, it is equipped with folding "ironing board" for easier and faster ironing of large surfaces, hanger with buckles for attaching, e.g. trousers and special attachment that protects delicate fabric from direct contact with the hot surface of the head.



PRICE & INFO

2 **TEXI 75S TAG GUN**

3 Tagging gun - standard

4 **TEXI 75F TAG GUN**

5 Tagging gun for fastening labels with
6 fine tagging pins



12 Needles for tag guns



PRICE & INFO



15 **TEXI 75S**
NEEDLE

16 Standard 1,85 mm



17 **TEXI 75F**
NEEDLE

18 Fine 1,32 mm



TEXI 75S
NEEDLE PREMIUM

Standard 1,85 mm



TEXI 75F
NEEDLE PREMIUM

Fine 1,32 mm

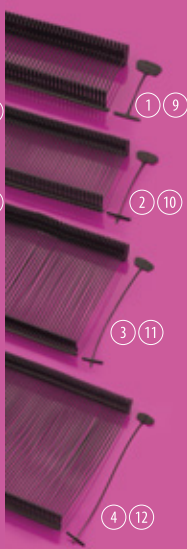
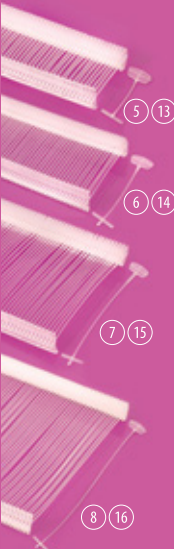

TEXI 75 PPS STANDARD

1	TEXI 75 PPS BLACK 015	15 mm
2	TEXI 75 PPS BLACK 025	25 mm
3	TEXI 75 PPS BLACK 045	45 mm
4	TEXI 75 PPS BLACK 065	65 mm
5	TEXI 75 PPS NEUTRAL 015	15 mm
6	TEXI 75 PPS NEUTRAL 025	25 mm
7	TEXI 75 PPS NEUTRAL 045	45 mm
8	TEXI 75 PPS NEUTRAL 065	65 mm

TEXI 75 PPF FINE

9	TEXI 75 PPF BLACK 015	15 mm
10	TEXI 75 PPF BLACK 025	25 mm
11	TEXI 75 PPF BLACK 045	45 mm
12	TEXI 75 PPF BLACK 065	65 mm
13	TEXI 75 PPF NEUTRAL 015	15 mm
14	TEXI 75 PPF NEUTRAL 025	25 mm
15	TEXI 75 PPF NEUTRAL 045	45 mm
16	TEXI 75 PPF NEUTRAL 065	65 mm

Pins for manual labeling

TEXI 75 PP SECUR LOOP 230

TEXI 75 PP SECUR LOOP 130





Worldwide distribution

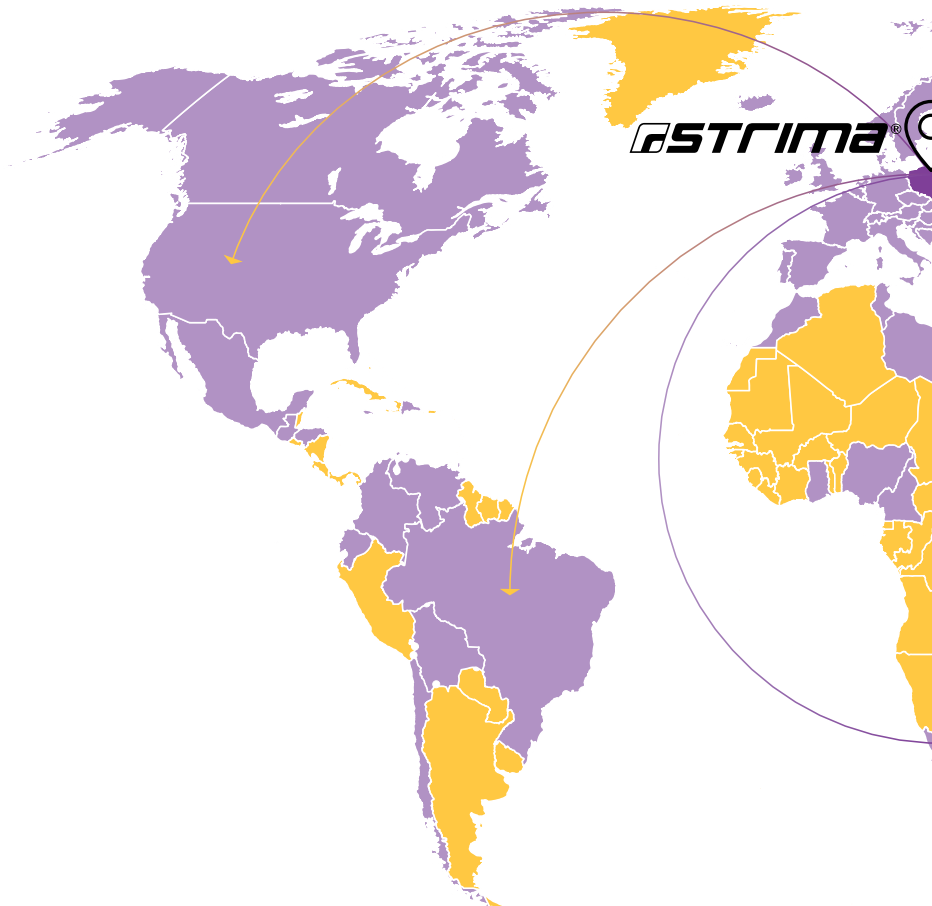

Strima Ltd. – Headquarter

+48 61 8 950 950
sales@strima.com

Swadzim, Poznanska Street 54
62-080 Tarnowo Podgorne, Poland

www.strima.com

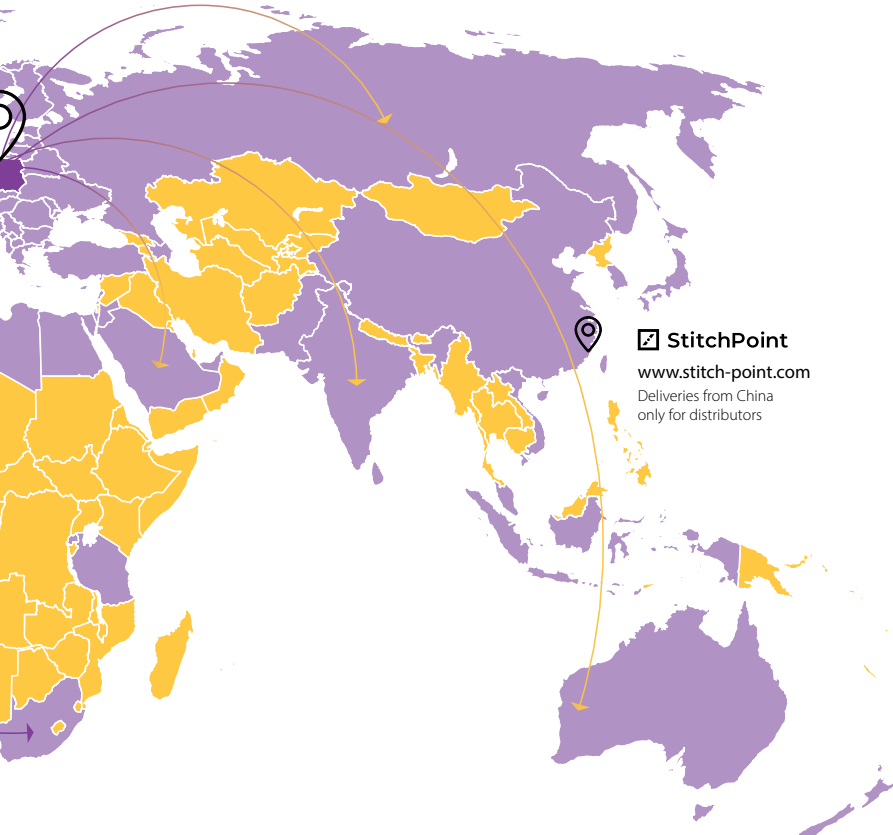

 **StitchPoint**

www.stitch-point.com

Deliveries from China
only for distributors

