

 **texi**®

*Culture of Sewing*



[strima.com](http://strima.com)



PL



KROJENIE	6
PRZEMYSŁOWE MASZYNY DO SZYCIA	12
SPECJALISTYCZNE MASZYNY	33
MASZYNY DO HAFTOWANIA	44
AKCESORIA DO MASZYN PRZEMYSŁOWYCH	46
IGŁY DO MASZYN PRZEMYSŁOWYCH	52
IGŁY DO MASZYN DOMOWYCH	54
DOMOWE MASZYNY DO SZYCIA	60
AKCESORIA DO MASZYN DOMOWYCH	82
PATCHWORK	98
PRASOWANIE	102
ETYKIETOWANIE	108

© Strima Sp. z o.o. Wszelkie prawa zastrzeżone.

Uczyniliśmy wszystko, aby informacje zawarte w tym prospekcie były najbardziej precyzyjne i aktualne. Zgodnie z naszą strategią stałego rozwoju produktów zastrzegamy sobie prawo modyfikowania ich elementów lub zmiany parametrów technicznych bez uprzedzenia. Żadna część tej publikacji nie może być powielana w jakiegokolwiek formie bez pisemnej zgody wydawcy. Prospekt ma charakter informacyjny i nie stanowi oferty handlowej. Wydrukowano w Polsce – kwiecień 2024.





TEXI to kompletne rozwiązanie dla pracowni modowych, tapicerskich i kaletniczych. Entuzjastom szycia oferujemy również nasze wsparcie i doradztwo. Portfolio produktów TEXI obejmuje przemysłowe i domowe maszyny do szycia, urządzenia do prasowania, metkowania i akcesoria krawieckie.

Marka TEXI powstała w 2009 roku w odpowiedzi na zapotrzebowanie klientów na energooszczędne, ciche i przyjazne dla użytkownika maszyny. Obecnie produkty TEXI są dystrybuowane w ponad 100 krajach na całym świecie. Jesteśmy częścią wielu ważnych wydarzeń modowych i promocyjnych takich jak Project Runway czy Forum Sztuki i Mody dla obiecujących talentów.



# Krojenie

## *texi Titanium* Nożyczki



CENA I INFO

- ✓ Powierzchnia ostrzy utwardzona tytanem
- ✓ Maksymalna odporność
- ✓ Dożywotnia gwarancja
- ✓ Miękki uchwyt



### **TI700**

Nożyczki krawieckie  
7" (18 cm) z tytanowanymi  
ostrzami



### **TI914**

Nożyce krawieckie 9 1/4"  
(23,5 cm) z tytanowanymi  
ostrzami



### **TI613 CRAFT**

Nożyczki tapicerskie 6 1/3"  
(16 cm) z tytanowanymi  
ostrzami



### **TI514**

Nożyczki hafciarskie  
hobbystyczno -  
rzemieślnicze 5 1/4" (13 cm)  
z tytanowanymi ostrzami



### **TI814**

Nożyce krawieckie 8 1/4"  
(21 cm) z tytanowanymi  
ostrzami



### **TIDU0850**

Ti 514 + Ti 814  
Zestaw: nożyce krawieckie  
8 1/4" (21 cm) + nożyczki  
hobbystyczno - rzemieślnicze  
5 1/4" (13 cm)

*texi Titanium*

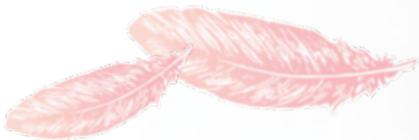

miękki uchwyt



KROJENIE

# texi. Noże krążkowe

## TEXI ZORRO 100

Noż tarczowy z silnikiem AC Servo



CENA I INFO

- średnica ostrza 100 mm
- bezobsługowy silnik AC Servo
- 5-stopniowa regulacja prędkości: 800, 950, 1100, 1250, 1400
- wysokość cięcia 27 mm
- lampa LED
- cicha praca
- lekki 1,3 kg



oświetlenie pola cięcia  
w technologii LED



## TEXI ZORRO 110 FREE

Nóż tarczowy **bezwodny** z silnikiem DC Servo

32 MM



AKUMULATOR



CENA I INFO

- średnica ostrza 110 mm
- bezobsługowy silnik DC Servo
- 5-stopniowa regulacja prędkości: 800, 950, 1100, 1250, 1400
- wysokość cięcia 32 mm
- lampa LED
- cicha praca
- lekki 1,5 kg



LED



3 stopniowe oświetlenie pola cięcia w technologii LED

# *texi* Maszyny do cięcia

## TEXI SIRIUS-P 1390

Ploter CO<sub>2</sub> do cięcia i grawerowania. Urządzenie laserowe do cięcia i znakowania tkanin, drewna, tworzyw sztucznych, plexi, gumy, szkła i ceramiki.



CENA I INFO



Moc lasera CO2	130 W
Pole pracy	1300 x 900 mm
Soczewka standardowa	2"
Prędkość cięcia	0 - 600 mm/sek.
Prędkość grawerowania	0 - 1060 mm/sek.
Dokładność pozycjonowania	+/- 0,05 mm
Chłodzenie	Wodne
System wyciągu dymu	Turbina
Typ stołu	Plaster miodu oraz żebrowy
Regulacja wysokości stołu	Elektroniczna
Panel sterowania	3" panel LCD Silniki: AC SERVO
Obsługa plików	PLT, AI, DXF, DST, BMP, JPG, itp.
Dodatkowe opcje	Przystawka rotacyjna, soczewka 3" (do cięcia grubszych materiałów)

## TEXI XYZ 2517

Nowoczesny jednowarstwowy cutter przeznaczony do automatycznego rozkroju tkanin, materiałów syntetycznych, tkanin technicznych, skór, sztucznych skór oraz innych materiałów.





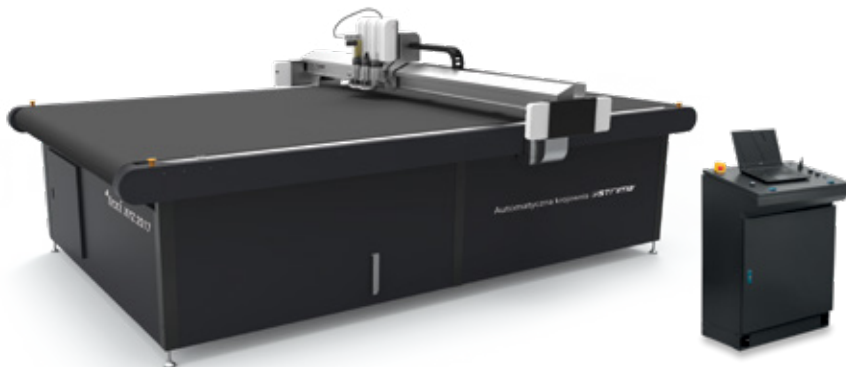



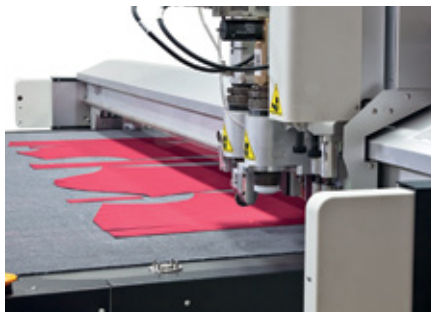















CENA I INFO





















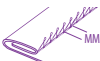

Pole pracy	2 500 x 1 700 mm
Wymiary urządzenia	3 350 x 2 550 mm
Minimalna szerokość drzwi przez które urządzenie może zostać zainstalowane w fabryce	2 600 mm z mostem / 2 150 mm bez mostu
Szerokość i długość podajnika materiału z silnikami	2 170 mm / 1 100 mm
Całkowita długość urządzenia wraz z zainstalowanym podajnikiem	5 520 mm + 600 mm komputer / minimum 6m
Maksymalna prędkość cięcia	1500 mm/s
Dokładność cięcia	do 0,1 mm
Maksymalna grubość cięcia	do 50 mm
Silniki	AC Servo
Moc turbiny	7,5 kW
Całkowita moc urządzenia	9 kW
Zasilanie urządzenia	400 V, 3 fazy
Oprogramowanie w języku	angielskim
Obsługa plików	PLT/HPGL, DXF, PDF



# Ikony maszyn do szycia *texi*

AUTO		AUTOMATYCZNE OBCINANIE NICI		TRANSPORT DOLNY, GÓRNY ROLKOWY I IGŁOWY
		AUTOMATYCZNE RYGLOWANIE		SYSTEM IGIEŁ
		ODRZUTNIK NICI		ROZSTAW IGIEŁ
		AUTOMATYCZNE PODNOŻENIE STOPKI		WYŁĄCZANIE IGŁY
		AUTOMATYCZNE POZYCJONOWANIE IGŁY		WYSOKOŚĆ PODNOŻENIA STOPKI
		KONTROLER ŚCIEGU POCZĄTKOWEGO		OŚWIETLENIE POLA PRACY
	TRANSPORT DOLNY		GRUBOŚĆ SZYTEGO MATERIAŁU	
	TRANSPORT IGŁOWY		PRĘDKOŚĆ SZYCIA	
	TRANSPORT DOLNY Z KROCZĄCĄ STOPKĄ		RODZAJ SILNIKA	
	POTRÓJNY TRANSPORT		LICZBA NICI	
	TRANSPORT RÓŻNICOWY			

	DŁUGOŚĆ ŚCIEGU		ROZMIAR DZIURKI DO GUZIKA
			ROZMIAR KLAMRY
			ROZMIAR NOŻA
			SYSTEM WIELOKROTNEGO CIĘCIA
			ROZMIAR RYGLOWANIA
			ŚREDNICA GUZIKA
STANDARD	SZEROKOŚĆ ŚCIEGU		PRZYSZYWANIE GUZIKÓW NA SŁUPKU
ZE WZMOCNIENIEM			POLE PRACY
			PRZESKOK ŚCIEGU (INTERWAŁ)
	LICZBA WZORÓW		WYSOKOŚĆ SŁUPKA
			OBWÓD SŁUPKA

# *texi* Stebnówki mechatroniczne 1-igłowe



## TEXI TRONIC 6 NEO

Automatyczna stebnówka z transportem dolnym



TRANSPORT DOLNY



CENA I INFO

	AUTO						
TEXI ART AUTO 2	✓	✓	-	✓	✓	✓	✓
TEXI TRONIC 3 NEO	✓	-	-	-	✓	-	✓
TEXI TRONIC 6 NEO	✓	✓	-	✓	✓	✓	✓
TEXI TRONIC 7 NF	✓	✓	✓	✓	✓	-	-

## TEXI TRONIC 7 NF

Automatyczna stebnówka z transportem igłowym



CENA I INFO



TRANSPORT IGŁOWY



## TEXI TRONIC 3 NEO

Stebnówka z automatycznym obcinaniem nici i transportem dolnym



CENA I INFO



TRANSPORT DOLNY



więcej str. 16 - 17

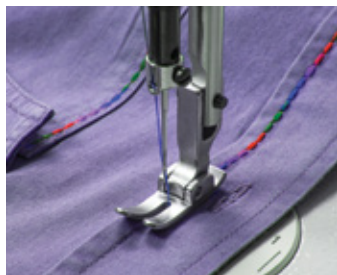

## TEXI ART AUTO 2 PREMIUM

Stebnówka automatyczna ze ścięciem dekoracyjnym do lekkich i średnich materiałów, z wbudowanym silnikiem krokowym i sterowaniem

-	135 x 5	5	13	✓	L/M	5 000	550 W
-	135 x 5	5	13	✓	L/M	5 000	550 W
-	135 x 5	5	13	✓	L/M	5 000	550 W
✓	135 x 5	4	13	✓	L/M	4 000	550 W



CENA I INFO

# Stebnówka z automatyką

## TEXI TRONIC 3 NEO

Stebnówka z automatycznym obcinaniem nici

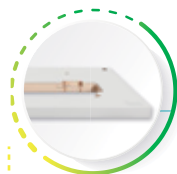

### Płyta stołu PREMIUM

#### Odporność

Płyta stołu (30 warstw sklejki brzozonej) pokryta laminatem odpornym na uderzenia, odpryski, ścieranie, oddziaływanie oleju oraz wilgoci.



### Solidna podstawa

#### Stabilność

Stabilne i trwałe podstawy Kessler z regulowaną wysokością





# w najlepszej cenie na rynku



Lampka LED  
Lepszy widok

Zawsze warto  
widzieć więcej



AC SERVO MOTOR  
Oszczędności

Oszczędzasz do 70% energii



# texi Stebnówka mechatroniczna 2-igłowa

## TEXI TWIN MS

Stebnówka 2-igłowa z transportem igłowym i automatycznym pozycjonowaniem igły



TRANSPORT IGŁOWY



2-IGŁOWA



### AUTO

-	-	-	-	PREMIUM EX	✓	135 x 5	6.4	✓	5	11	✓	L/M	3 000	550 W	

## PREMIUM



WARRANTY  
PREMIUM

najlepsza cena



## PREMIUM EX











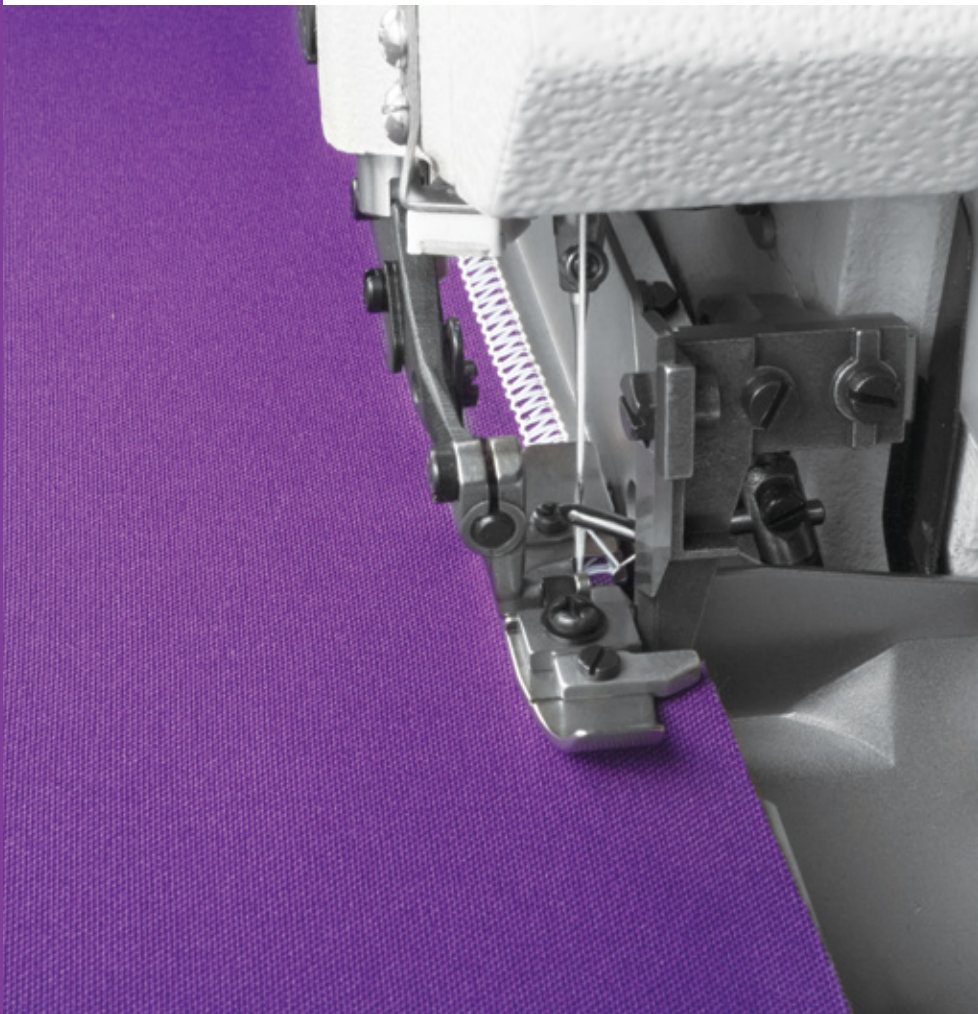

EXTENDED WARRANTY  
PREMIUM EX

dotychczasowe  
wyposażenie  
w standardzie



WYDŁUŻONA GWARANCJA  
NA MASZYNY PRZEMYSŁOWE  
+ EKSTRA GRATISY



		AUTO								
								SYSTEM	MM	
16	TEXI TRE 04 N	-	-	-	-	✓	✓	1	B-27	-
17	TEXI QUATTRO 24 N	-	-	-	-	✓	✓	2	B-27	2
18	TEXI CINQUE 35 N	-	-	-	-	✓	✓	2	B-27	3

## TEXI QUATTRO 24 N

Overlok mechaniczny  
4-nitkowy



CENA I INFO

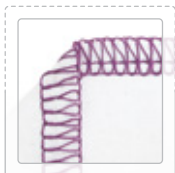

## TEXI TRE 04 N

Overlok mechaniczny 3-nitkowy



CENA I INFO



## TEXI CINQUE 35 N

Overlok mechaniczny 5-nitkowy









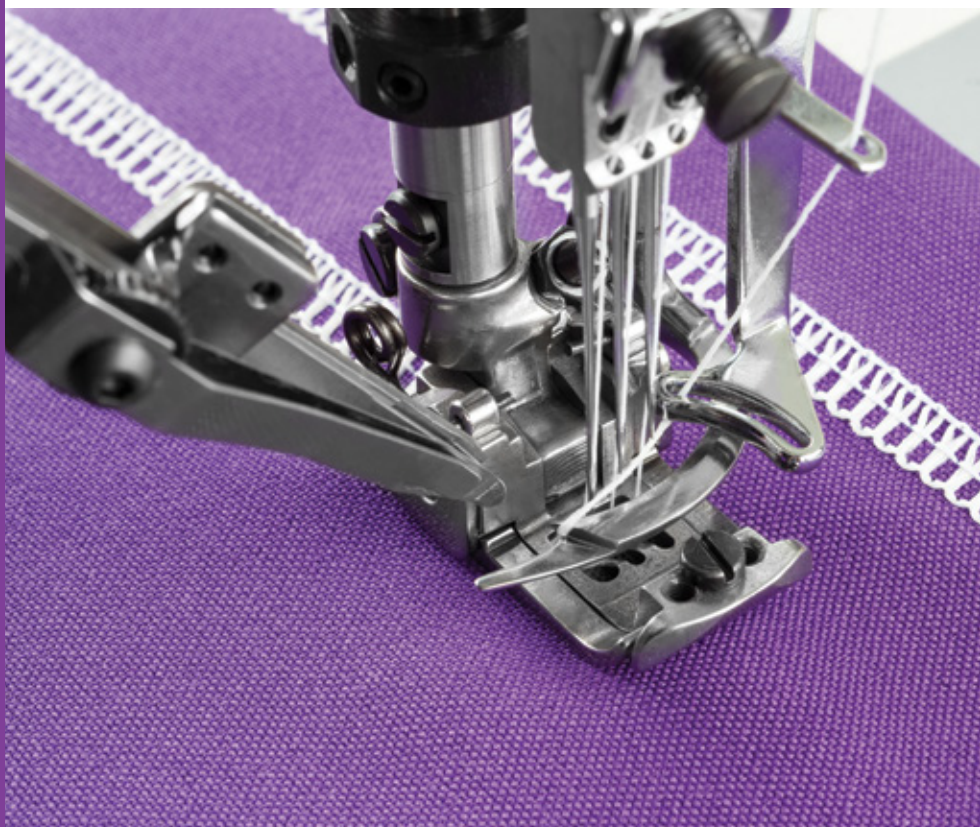

CENA I INFO



3	4 mm	-	4 mm	6	✓	L/M	7 000	550 W
4	6 mm	-	4 mm	6	✓	L/M	7 000	550 W
5	5 mm	8 mm	4 mm	6	✓	L/M	7 000	550 W



								
TEXI TRECCIA N	-	-	-	-	✓	1:0.5 ~ 1:1.3	3	
TEXI TRECCIA C MATIC	✓	-	✓	✓	✓	1:0.5 ~ 1:1.3	3	

## TEXI TRECCIA N

Interlok 3-igłowy o płaskim łożu



CENA I INFO



PŁASKIE ŁOŻE



## TEXI TRECCIA C MATIC

Interlok 3-igłowy o cylindrycznym łożu



CENA I INFO



CYLINDRYCZNE  
ŁOŻE



PRZEMYSŁOWE MASZYNY DO SZYCIA

SYSTEM				MM		CYLINDER-BED		AC SERVO 230V
UY 128 GAS	5.6 / 6.4	5	1.6 ~ 4.2 mm	6	✓	-	6 000	550 W
UY 128 GAS	5.6 / 6.4	5	1.6 ~ 4.2 mm	6	✓	✓	6 000	550 W

# texi. Specjalistyczne maszyny do szycia

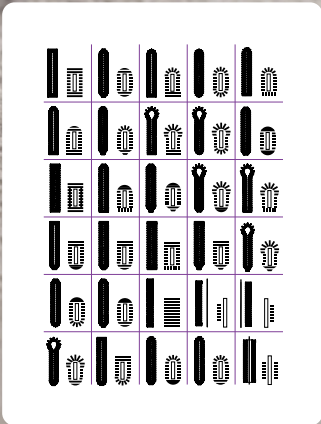

## TEXI O NEO

Dziurkarka bielizniana elektroniczna



CENA I INFO



AUTO					SYSTEM	PATTERNS	A	A	MULTI CUT	MM				AC SERVO 230 V
✓	-	-	✓	-	135 x 5	30	A = 9.4 - 41.0 B = 0.1 - 5.0	A = 29, B = 5 A = 40, B = 6	✓	14	✓	L/M	3 600	550 W



## TEXI 781 SERVO

Dziurkarka bieliżniana



CENA I INFO



AUTO													
✓	-	-	-	-	135 x 5	30 x 6	A = 6.4 - 25.4 B = 2.5 - 5	6.4 - 19.1	12	✓	L/M	3 600	550 W
							A = 6.4 - 31.8 B = 2.5 - 5	6.4 - 31					

## TEXI CATENACCIO 2.0

Ryglówka elektroniczna



CENA I INFO



ZAWIERA ZESTAW  
DO GRUBYCH  
TKANIN

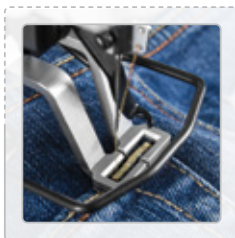

AUTO													
✓	-	✓	✓	-	135 x 5	A = 20 B = 4.5	A = 18 B = 4	15 (100)	16	✓	L/M/H	3 000	550 W

## TEXI X

Dziurkarka elektroniczna



CENA I INFO

Wzory z cyklu



8, 16, 32

### AUTO



SYSTEM



MM



Ø = 10~28



A: 2.5 - 6.5



kolba



1 500



AC SERVO  
230V

550 W

## TEXI ZIGGY

Zygzak elektroniczny z automatycznymi funkcjami



CENA I INFO



Podstawowe  
ścigi

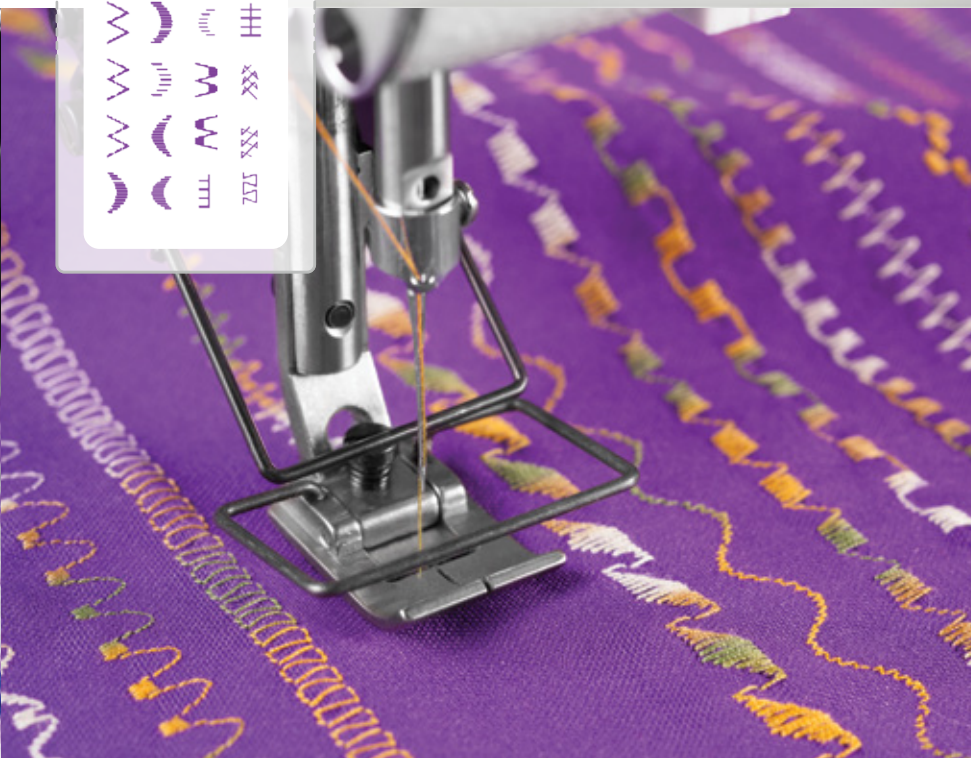

PRZEMYSŁOWE MASZYNY DO SZYCIA

AUTO

✓	✓	✓	✓	✓	135 x 5	29	114	5.0	10.0	6	✓	L/M	5 000	550 W

[www.strima.com](http://www.strima.com)

27

## TEXI ACCURA

Podszycarka do ściegu jednostronnie krytego, do cienkich i średnich materiałów

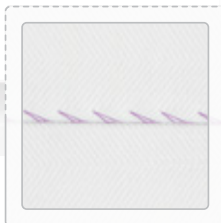

CENA I INFO



TEXI COMPACTA



3.0 - 8.0



INTERVAL

1:1/1:2

TEXI ACCURA

3.0 - 8.0

1:1/1:2

## TEXI COMPACTA

Przeñona podszywarka do ściegu jednostronnie krytego, do cienkich i średnich materiałów



**MASZYNA  
PRZEÑOŠNA**

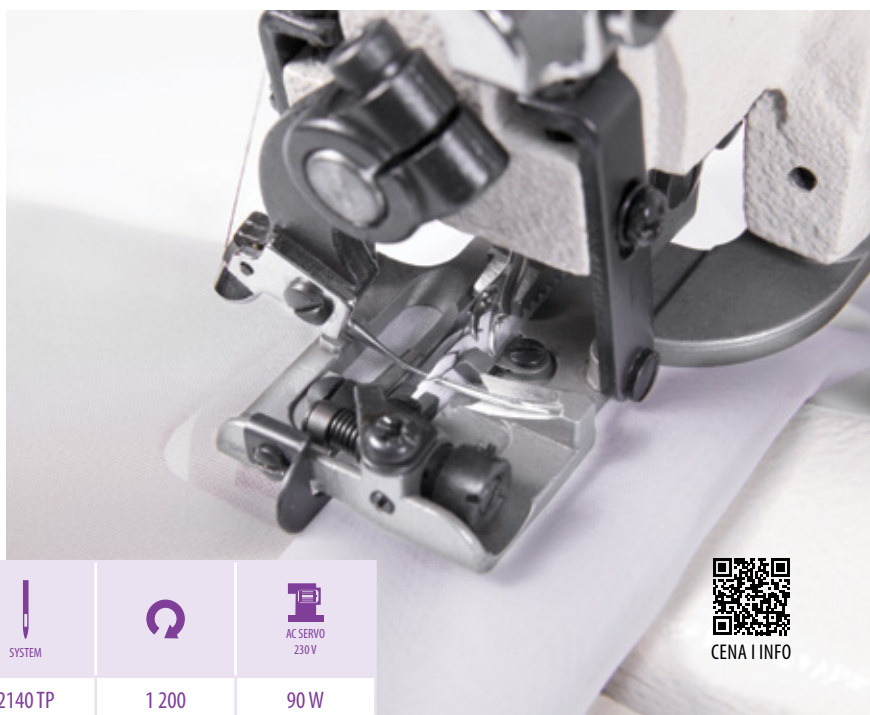

SYSTEM



AC SERVO  
230 V

2140 TP

1 200

90 W

2140 TP

2 500

550 W



CENA I INFO

## TEXI SEP SYSTEM

Maszyna wielofunkcyjna do szycia, haftowania i perforowania materiałów powlekanych i skór



CENA I INFO



### POLE PRACY

TEXI SEP System  
= 1 200 x 800 mm

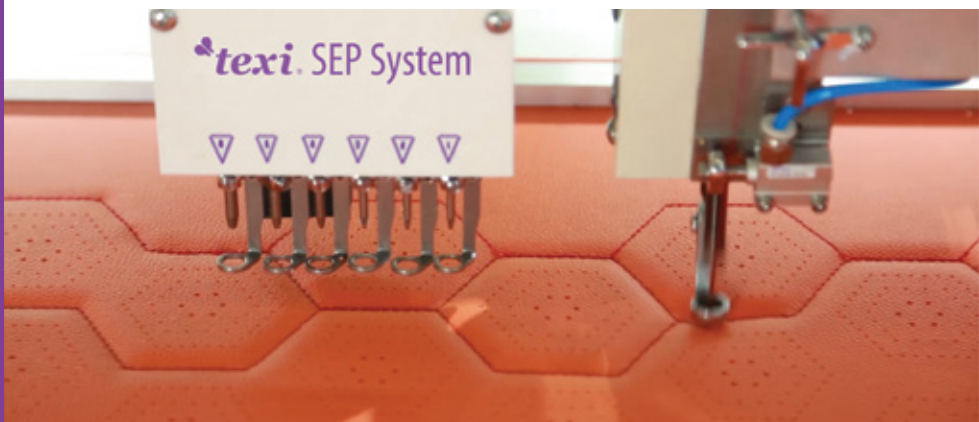

MODEL	TEXI SEP SYSTEM	TEXI SP SYSTEM	TEXI SP 360 SYSTEM
Pole pracy	1 200 x 800 mm		
Wielkość chwytacza/szpulki	XXL / 26 mm		
Maks. grubość nici	20		
Szycie	✓		
Szycie: liczba igieł	1		
Szycie: rotacyjna głowica	–	–	✓ 360°
Szycie: podnosząca głowica	✓ 50 mm		
Maksymalna prędkość szycia	1 000 ściegów/min	1 000 ściegów/min	1 200 ściegów/min
Wysokość podnoszenia stopki	18 mm		
Maks. długość ściegu	12,7 mm		
Haftowanie	✓	–	–
Liczba igieł	9	–	–
Maksymalna prędkość haftu	850 ściegów/min	–	–
Perforacja	✓		
Perforacja: liczba noży	6		
Perforacja: możliwe rozmiary noży	0,8 mm, 1,0 mm, 1,2 mm, 1,5 mm, 2,0 mm, 2,5 mm		
Maksymalna prędkość perforacji	800 otworów/min		
Automatyczne obcinanie nici	✓		
Czujnik zerwanej nici	✓		
Panel dotykowy	✓		
Zasilanie	230 V lub 380 V		
Moc	5,5 kW	5,1 kW	4,5 - 4,8 kW
Kontroler ściegu pocątkowego	✓		
Oświetlenie pola pracy LED	✓		
Sprężone powietrze	✓		

## TEXI PERFO DUO

Maszyna do perforowania, sterowana komputerowo, to kluczowe narzędzie dla producentów mebli, tapicerki samochodowej oraz branży odzieżowej.



CENA I INFO

### POLE PRACY

TEXI PERFO DUO  
= 1 200 x 800 mm

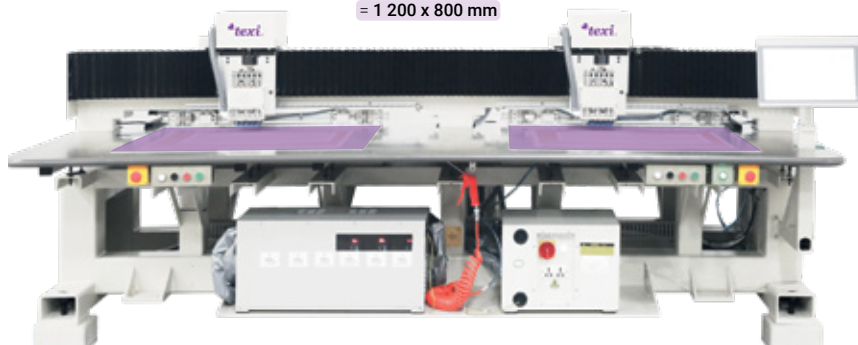

MODEL	TEXI PERFO 1200x800 DUO	TEXI PERFO 900x600 DUO
Pole pracy	2 x 1200 x 800 mm	2 x 900 x 600 mm
Perforacja		✓
Perforacja: liczba noży		6
Perforacja: możliwe rozmiary noży	0,8 mm, 1,0 mm, 1,2 mm, 1,5 mm, 2,0 mm, 2,5 mm	
Maksymalna prędkość perforacji	1 200 otworów/min	
Panel dotykowy		✓
Zasilanie	230 V	
Moc	3 kW	
Kontroler ściegu początkowego		✓
Oświetlenie pola pracy LED		✓
Sprężone powietrze		✓

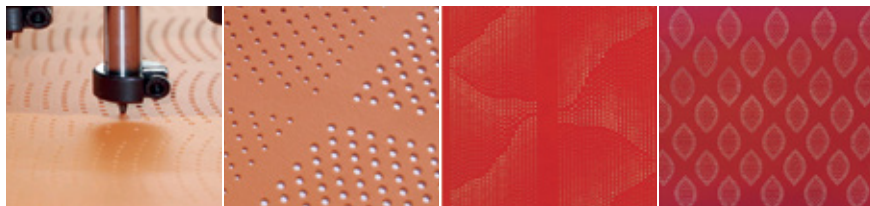



## TEXI FREE 360

Automatyczna maszyna do szycia programowanych wzorów z dużym polem pracy z precyzyjną, obrotową głowicą szyjącą oraz trzema niezależnymi napędami: głowicy, chwytacza i ramy.



CENA I INFO

### POLE PRACY

TEXI FREE 360 LF 150X90 SET  
= 1 500 x 900 mm

TEXI FREE 360 XLF 250X130 SET  
= 2 500 x 1 300 mm

TEXI FREE 360 XXLF 250X150 SET  
= 2 500 x 1 500 mm



DUŻE POLE PRACY









MODEL	FREE 360 LF 150X90 SET	FREE 360 XLF 250X130 SET	FREE 360 XXLF 250X150 SET
Rodzaj szyciego materiału		Grube i trudne	
Pole pracy	1 500 x 900 mm	2 500 x 1300 mm	2 500 x 1500 mm
Wielkość chwytacza/szpułki		XXL / 26 mm	
Maks. grubość nici		20	
Automat. obcinanie nici		✓	
Czujnik zerwanej nici		✓	
Panel dotykowy		✓	
Oświetlenie pola pracy LED		✓	
Maks. prędkość szycia		3 000 ściegów/min	
Wysokość podnoszenia stopki		22 mm	
Maks. długość ściegu		12,7 mm	
System igieł		135 x 17	
Zasilanie		230 V	
Obrotowa igielnica 360 stopni		✓	
Moc silnika		750 W	
Sprężone powietrze		✓	

# **texi** Seria Walker

Stebnówki tapicerskie i kaletnicze do szycia grubych materiałów



	AUTO				
					
TEXI WALKER WF SERVO	-	-	-	-	✓
TEXI WALKER WF AUT	✓	✓	✓	✓	✓

## TEXI WALKER WF SERVO

Stebnówka tapicerska i kaletnicza



CENA I INFO

## TEXI WALKER WF AUT

Automatyczna stebnówka tapicerska i kaletnicza











AUTO



CENA I INFO



SPECJALISTYCZNE MASZYNY

	 SYSTEM	 MM	 CM	 MM				 AC SERVO 230 V
✓	135 x 17	8	33,5	16	✓	M/H	2 000	550 W
✓	135 x 17	8	33,5	16	✓	M/H	2 000	550 W

# texi<sup>HD</sup> Seria HD

Stebnówki, lamowarki tapicerskie i kaletnicze - bardzo grube szycie

## TEXI HD FORTE UF

Stebnówka tapicerska,  
kaletnicza z potrójnym  
transportem









CENA I INFO



POTRÓJNY TRANSPORT



	AUTO					
						
 TEXI HD FORTE UF	-	-	-	-	✓	✓
TEXI HD FORTE-B UF	-	-	-	-	✓	✓
TEXI HD FORTE CILINDRO UF	-	-	-	-	✓	✓
TEXI HD FORTE CILINDRO-B UF	-	-	-	-	✓	✓

## TEXI HD FORTE-B UF

Stebnówka tapicerska, kaletnicza z funkcją lamowania



CENA I INFO



POTRÓJNY TRANSPORT



## TEXI HD FORTE CILINDRO UF

Stebnówka cylindryczna, tapicerska, kaletnicza



CENA I INFO



POTRÓJNY TRANSPORT



## TEXI HD FORTE CILINDRO-B UF

Stebnówka z cylindryczna, tapicerska, kaletnicza z funkcją lamowania









CENA I INFO



POTRÓJNY TRANSPORT



SPECJALISTYCZNE MASZYNY

 SYSTEM	 CM	 MM	 MM		 AC SERVO 230 V	 CYLINDER-BED	 BINDING
134 - 35	26	8	14	2 800	750 W	-	-
134 - 35	26	8	14	2 800	750 W	-	✓
134 - 35	26	6	14	2 800	750 W	✓	-
134 - 35	26	6	14	2 800	750 W	✓	✓

# 121 **texi** Seria RAM



## TEXI RAM B-T

Stebnówka z odkrawiaczem krawędziowym i urządzeniem wiążącym



CENA I INFO



## TEXI RAM R-A

stebnówka z funkcją marszczenia, z mechanizmem różnicowym do szwów marszczonych



CENA I INFO

## TEXI RAM TN

Stebnówka dwuigłowa



DWUIGŁOWA



CENA I INFO

	AUTO				 PODWÓJNA	 MM	
TEXI RAM	-	-	-	✓	-	-	✓
TEXI RAM A	✓	✓	✓	✓	-	-	✓
TEXI RAM TN	-	-	-	✓	✓	12	✓
TEXI RAM B-T	-	-	-	✓	-	-	✓
TEXI RAM R-A	✓	✓	✓	✓	-	-	✓
TEXI RAM L-A	✓	✓	✓	✓	-	-	✓
TEXI RAM TN-L-A	✓	✓	✓	✓	✓	12	✓



### TEXI RAM

Stebnówka jednoigłowa



CENA I INFO



### TEXI RAM A

Automatyczna stebnówka jednoigłowa



CENA I INFO



### TEXI RAM L-A

Stebnówka jednoigłowa z powiększonym obszarem roboczym



CENA I INFO

### TEXI RAM TN-L-A

Stebnówka dwuigłowa z powiększonym obszarem roboczym



CENA I INFO



DWUIGŁOWA



POLE PRACY  
63,5 CM

SYSTEM	CM	MM	MM	MM	MM	MM	AC SERVO 230V
134 - 35	25,5	28	9	16	M/H	2 500	800 W
134 - 35	33,5	28	9	16	M/H	2 500	800 W
134 - 35	25,5	28	9	16	M/H	2 000	800 W
134 - 35	25,5	28	9	16	M/H	2 000	800 W
134 - 35	25,5	28	9	16	M/H	2 000	800 W
134 - 35	63,5	28	9	16	M/H	2 000	800 W
134 - 35	63,5	28	9	16	M/H	2 000	800 W



DWUIGŁOWA

### TEXI RAM TN-P

Dwuigłowa stebnówka słupkowa



CENA I INFO



DWUIGŁOWA

### TEXI RAM TN-P-A

Automatyczna dwuigłowa stebnówka słupkowa



CENA I INFO

	AUTO				 PODWÓJNA	 SYSTEM	 CH	 MM	 MM	 MM			 AC SERVO 230 V		
TEXI RAM TN-P	-	-	✓	-	✓	✓	134 - 35	16	26	9	16	✓	M/H	2 000	800 W
TEXI RAM TN-P-A	✓	✓	✓	✓	✓	✓	134 - 35	16	26	9	16	✓	M/H	2 000	800 W



### TEXI RAM C

Stebnówka cylindryczna, jednoigłowa



CENA I INFO



### TEXI RAM C-A

Automatyczna stebnówka cylindryczna, jednoigłowa



CENA I INFO

	AUTO				 SYSTEM	 CH	 MM	 MM	 CYLINDER-BED			 AC SERVO 230 V	
TEXI RAM C	-	-	-	✓	✓	134 - 35	25,5	9	16	✓	M/H	2 500	800 W
TEXI RAM C-A	✓	✓	✓	✓	✓	134 - 35	25,5	9	16	✓	M/H	2 500	800 W



## TEXI POST DD PREMIUM

Stebnówka słupkowa  
z transportem dolnym i górnym  
rolkowym oraz igłowym



CENA I INFO

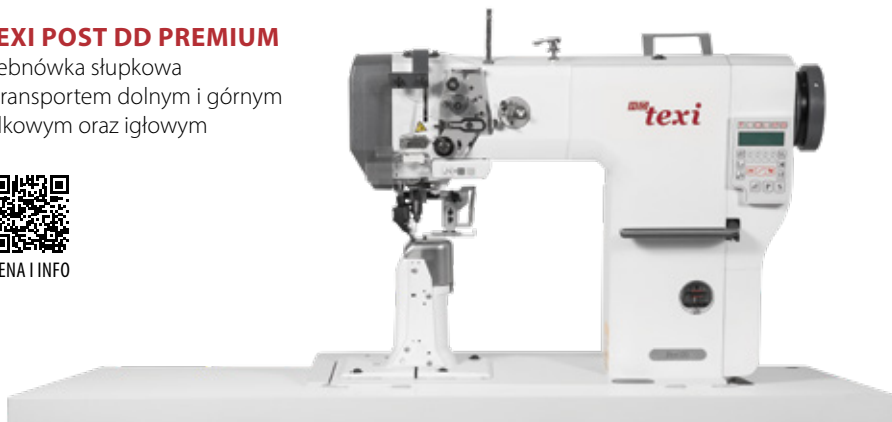

SPECJALISTYCZNE MASZYNY

### AUTO

✓	✓	-	-	✓	✓	135 x 5	17	21 mm	4.5	8	✓	M/H	3 000	750 W				

**TEXI NOVA P-OS 3212**









Automatyczna słupkowa stebnowka dwuigłowa ze ściegiem ozdobnym



CENA I INFO



DWUIGŁOWA

	AUTO				 PODWÓJNA	 MM	
							
TEXI NOVA 2609	✓	✓	✓	✓	-	-	✓
TEXI NOVA 3212	✓	✓	✓	✓	-	-	✓
TEXI NOVA TN 3212	✓	✓	✓	✓	✓	12	✓
TEXI NOVA P-OS 3212	-	✓	✓	✓	✓	8	✓

## TEXI NOVA 2609

Automatyczna stebnówka tapicerska jednoigłowa. Duża szpulka 26 mm



CENA I INFO



SZPULKA XXL



DWUIGŁOWA

## TEXI NOVA 3212

Automatyczna jednoigłowa stebnówka tapicerska

Duża szpulka 32 mm



CENA I INFO

## TEXI NOVA TN 3212

Automatyczna dwuigłowa stebnówka tapicerska

Duża szpulka 32 mm



CENA I INFO

 SYSTEM	 MM	 MM	 CM	 MM				 AC SERVO 230 V
134 - 35	26	16	35,1	9	✓	M/H	3 400	800 W
134 - 35	32	16	35,1	12	✓	H/XH	3 400	800 W
134 - 35	32	16	35,1	12	✓	H/XH	3 400	800 W
134 - 35	32	16	35,5	12	✓	H	800	800 W



### TEXI 1501 XL TS

Kompaktowa hafciarka przemysłowa **15-igłowa**

- Maksymalne pole haftu 600 x 400 mm
- Prędkość szycia 1,000 ściegów/min
- Ekran dotykowy, połączenie WiFi
- 11 tamborków (6 rozmiarów)
- Czapki, haft płaski i inne



CENA I INFO

Szkolenie z obsługi  
i dostawa w cenie



CENA I INFO



## TEXI IRIS 12

Kompaktowa hafciarka  
przemysłowa **12-igłowa**

- Pole haftu  
300 x 200 mm
- Prędkość szycia  
1.000 ściegów/min
- Ekran dotykowy
- 4 tamborki (4 różne  
rozmiary)
- Czapki, haft płaski i inne

**TEXI 4003**

Trzpień do szybkiego  
wymieniania stopek



CENA I INFO

**HIT!**

### TEXI 3 FEET

Głowica rewolwerowa  
na 3 stopki  
do stebnowki



CENA I INFO

### TEXI 4026

Obcinacz nitki do  
stebnowek  
przemysłowych



CENA I INFO

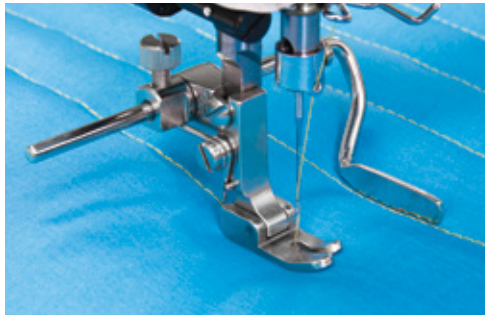
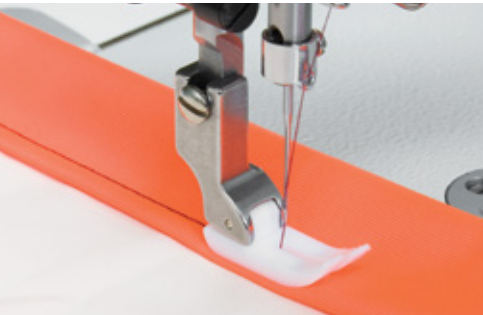
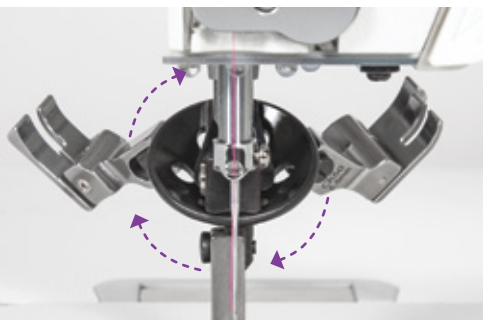

### TEXI 5001

Stopka do szycia skór  
i trudnych materiałów,  
ułatwia transport



CENA I INFO

### TEXI 5003

Stopka z liniałami prawym  
i lewym do równego stebnowania  
w zakresie 5 - 55 mm



CENA I INFO

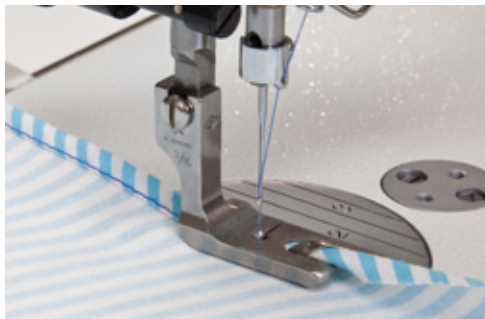

### TEXI 5004

Stopka PTFE z pierścieniami  
do szycia wielowarstwowych  
projektów



CENA I INFO

### TEXI 5006

Stopka podwójnie  
zwijająca 1/8" (3,2 mm)



CENA I INFO

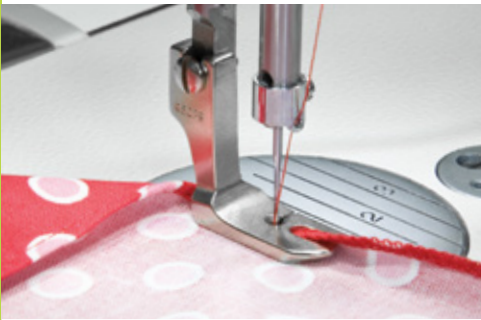

### TEXI 5007

Stopka zwijająca 1/8"  
(3,2 cm)



CENA I INFO



### TEXI 5010

Stopka do marszczenia  
regulowana



CENA I INFO



Stopka krawędziowa wąska  
do wszywania zamków i szycia  
blisko krawędzi

### TEXI 5008

Lewa



CENA I INFO

### TEXI 5009

Prawa



CENA I INFO



### TEXI 5011

Stopka do  
wszywania zamków  
z zamkami płozami



CENA I INFO

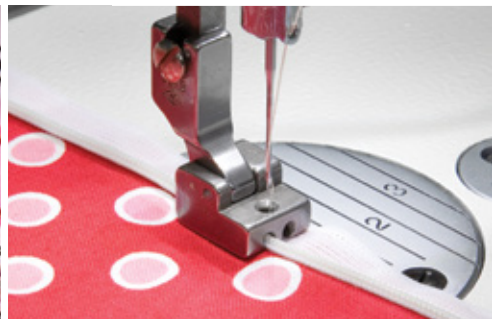

### TEXI 5012

Stopka do wszywania  
zamków krytych



CENA I INFO





### TEXI 5013

Stopka uniwersalna



CENA I INFO

### TEXI 5014

Stopka rolkowa do trudnych materiałów, skaju i skór



CENA I INFO

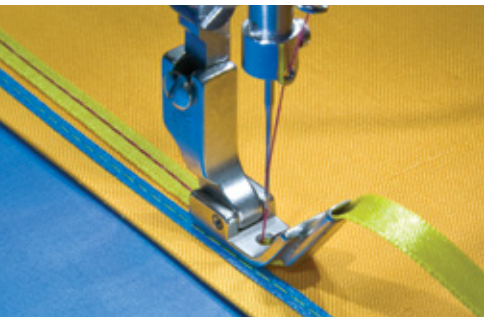

### TEXI 5015

Stopka z prowadnikiem do naszywania taśmy o szer. do 4,8 mm



CENA I INFO

### TEXI 5020

Stopka do wszywania kedry 3,2 mm lewa



CENA I INFO



Stopka kompensacyjna do równego stebnowania, 1,0 mm

### TEXI 5016

Prawa



CENA I INFO

### TEXI 5017

Lewa



CENA I INFO

1  
2  
3  
4  
5  
6  
7  
8  
9  
10  
11  
12  
13  
14  
15  
16  
17  
18  
19



Stopka pokryta PTFE  
kompensacyjna do równego  
stebnowania, 1,0 mm

### TEXI 5018

Prawa



CENA I INFO

### TEXI 5019

Lewa



CENA I INFO



### TEXI 5021

Stopka do zwijacza



CENA I INFO



### TEXI 5022

Stopka do delikatnych  
materiałów



CENA I INFO



### TEXI 5023

Stopka do grubych  
materiałów



CENA I INFO



### TEXI 6001

Lamownik podwójnie  
zawijający 30/8 mm



CENA I INFO

8 mm



### TEXI 6002

Lamownik składający na pół 5/8" (16/8 mm)



CENA I INFO

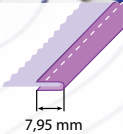

7,95 mm



### TEXI 6003

Zwijacz podwójnie podwijający 3/8" (9,53 mm)



CENA I INFO



9,53 mm

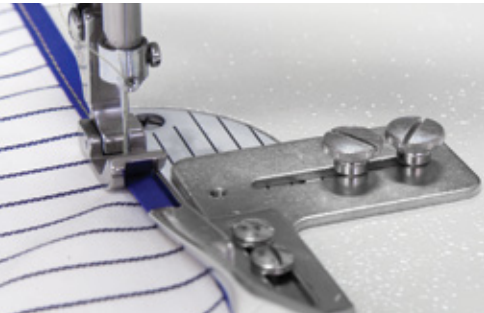

### TEXI 4004

Wkręt uniwersalny do mocowania lamowników, zwijaczy i linałów (2 szt.)



CENA I INFO



### TEXI 4009

Liniał magnetyczny



CENA I INFO

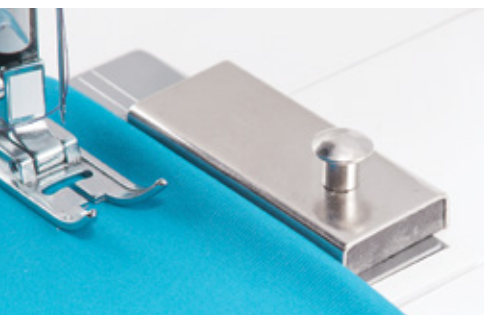

### TEXI 4010

Liniał magnetyczny - długi (50 mm) i bardzo mocny



CENA I INFO



### TEXI 4021

Liniał uchylny



CENA I INFO



## CZUBKI IGIEŁ DO TKANIN I DZIANIN

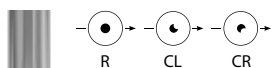

Okrągły standardowy czubek do tkanin, ale także do dzianin i skóry w zależności od grubości igły i technologii szycia

CL i CR - z rowkiem wyprowadzającym nitkę z oczka, do twardych materiałów

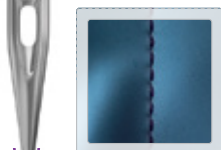

Okrągły bardzo ostry czubek do tkanin o gęstym splocie, np. mikrofaza, jedwab, a także do stebnowania widocznych elementów

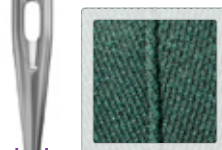
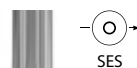

Okrągły czubek z małą kulką do delikatnych dzianin z cienkiej przędzy o dużej gęstości oczek oraz do denimu

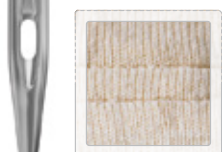

Okrągły czubek ze średnią kulką do grubszych dzianin i materiałów elastycznych

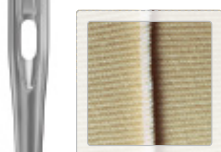

Okrągły czubek z dużą kulką do grubych dzianin, a także cienkiej lycry w kombinacji z małą średnicą igły (65-70)

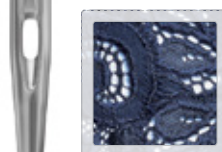

Okrągły czubek ze specjalną kulką do dzianin z gumką, dzianin o zróżnicowanym splocie, a także grubej lycry

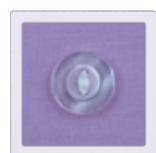

Specjalny okrągły czubek do przyszywania guzików

# Ostrza igieł do skór, materiałów powlekanych, wymagających nacięcia podczas szycia

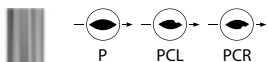

Do wszystkich rodzajów skóry, tnie poprzecznie do kierunku ściegu, dając krótki, mocny ścieg

PCL i PCR - z rowkiem wyprowadzającym nitkę z oczka



Do wszystkich rodzajów skóry, tnie wzdłuż ściegu, umożliwiając prosty długi ścieg

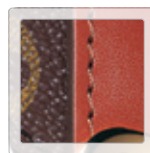

Do wszystkich rodzajów skóry, tnie w prawo po skosie, dając dekoracyjny ścieg z lekkim skrętem w lewo

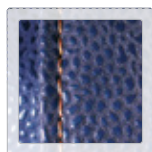

Do wszystkich rodzajów skóry, tnie w lewo po skosie, dając prosty, lekko zagłębiony ścieg

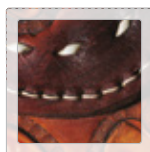

Do grubej, suchej, twardej skóry, tnie wzdłuż ściegu, dając prosty, zagłębiony ścieg

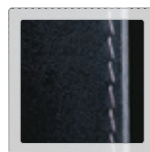

Do grubej, suchej, twardej skóry, tnie w prawo po skosie, dając dekoracyjny ścieg z lekkim skrętem w lewo

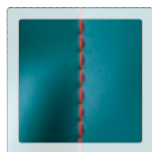

Do materiałów laminowanych



Do zszywania twardych elementów montażowych tapicerki z tkaniną lub skórą

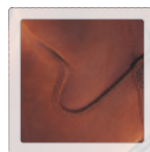
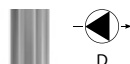

Do bardzo grubej, suchej, twardej skóry, umożliwia prosty ścieg



# Igły *texi* do maszyn domowych

Z KOLORAMI ŁATWIEJ DOBIERZESZ!

ZASTOSOWANIE

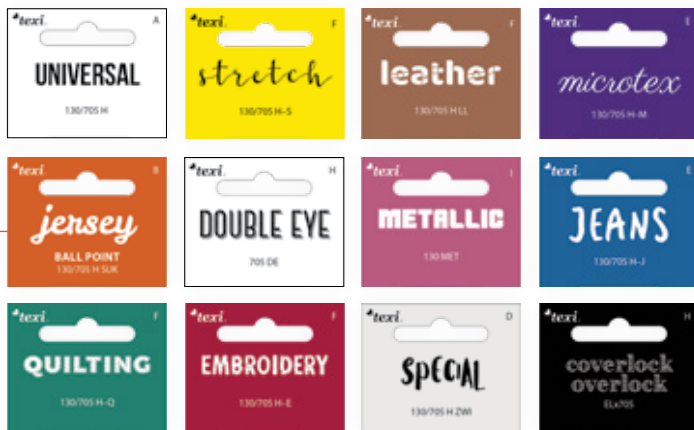

60 65

70

75 80 90 100 110 120 125 130

GRUBOŚĆ IGŁY (W NM)

# Igły *texi* do maszyn domowych

## TEXI UNIVERSAL

Igły uniwersalne przeznaczone do większości tkanin, także do dzianin, tkanin syntetycznych itp.



CENA I INFO

	UNIVERSAL 130/705 H 5x60
	UNIVERSAL 130/705 H 5x70
	UNIVERSAL 130/705 H 5x80
	UNIVERSAL 130/705 H 5x90
	UNIVERSAL 130/705 H 5x100
	UNIVERSAL 130/705 H 5x110
	UNIVERSAL 130/705 H 5x120
	UNIVERSAL 130/705 H 2x70, 2x80, 1x90
	UNIVERSAL 130/705 H 1x70, 2x80, 1x90, 1x100
	UNIVERSAL 130/705 H 10x70
	UNIVERSAL 130/705 H 10x80
	UNIVERSAL 130/705 H 10x90
	UNIVERSAL 130/705 H 10x100
	UNIVERSAL 130/705 H 2x70, 3x80, 3x90, 2x100
	UNIVERSAL 130/705 H 10x60-110



## TEXI STRETCH

Igły do stretchu i dzianin



CENA I INFO

	STRETCH 130/705 H-S 5x65
	STRETCH 130/705 H-S 5x75
	STRETCH 130/705 H-S 5x90
	STRETCH 130/705 H-S 3x75, 2x90



## TEXI JERSEY

Igły kulkowe (średnia kulka) do szycia materiałów elastycznych



CENA I INFO

	JERSEY 130/705 H SUK 5x70
	JERSEY 130/705 H SUK 5x80
	JERSEY 130/705 H SUK 5x90
	JERSEY 130/705 H SUK 5x100
	JERSEY 130/705 H SUK 2x70, 2x80, 1x90





## TEXI JEANS

Igły do denimu (jeansu)



CENA I INFO

	JEANS 130/705 H-J 5x70
	JEANS 130/705 H-J 5x80
	JEANS 130/705 H-J 5x90
	JEANS 130/705 H-J 5x100
	JEANS 130/705 H-J 5x110
	JEANS 130/705 H-J 2x90, 2x100, 1x110



## TEXI LEATHER

Igły do szycia skóry, sztucznej skóry oraz podobnych materiałów.



CENA I INFO

	LEATHER 130/705 H LL 5x70
	LEATHER 130/705 H LL 5x80
	LEATHER 130/705 H LL 5x90
	LEATHER 130/705 H LL 5x100
	LEATHER 130/705 H LL 5x110
	LEATHER 130/705 H LL 5x120
	LEATHER 130/705 H LL 2x80, 2x90, 1x100

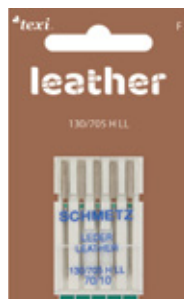

## TEXI MICROTEx

Igły do jedwabiu i mikrofazy



CENA I INFO

	MICROTEx 130/705 H-M 5x60
	MICROTEx 130/705 H-M 5x70
	MICROTEx 130/705 H-M 5x80
	MICROTEx 130/705 H-M 5x90
	MICROTEx 130/705 H-M 2x60, 2x70, 1x80



## TEXI QUILTING

Igły do quiltingu oraz patchworku



CENA I INFO

	QUILTING 130/705 H-Q 5x75
	QUILTING 130/705 H-Q 5x90
	QUILTING 130/705 H-Q 3x75, 2x90



## TEXI EMBROIDERY

Igły do haftu, z większym oczkiem do grubszych nici



CENA I INFO

- EMBROIDERY 130/705 H-E 5x75
- EMBROIDERY 130/705 H-E 5x90
- EMBROIDERY 130/705 H-E 3x75, 2x90

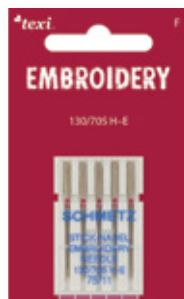

## TEXI METALLIC

Igły do haftu nićmi metalicznymi z bardzo długim oczkiem (2 mm)



CENA I INFO

- METALLIC 130 MET 5x80
- METALLIC 130 MET 5x90



## TEXI DOUBLE EYE

Igły z podwójnym oczkiem przeznaczone do jednoczesnego szycia dwoma nitkami



CENA I INFO

- DOUBLE EYE 705 DE 5x80



## TEXI UNIVERSAL TWIN

Igła podwójna do ściegu ozdobnego, aplikacji i ściegu zygzakowego



CENA I INFO

- UNIVERSAL TWIN 130/705 H ZWI NE 2,0-80
- UNIVERSAL TWIN 130/705 H ZWI NE 2,5-80
- UNIVERSAL TWIN 130/705 H ZWI NE 3,0-90
- UNIVERSAL TWIN 130/705 H ZWI NE 4,0-80
- UNIVERSAL TWIN 130/705 H ZWI NE 4,0-90
- UNIVERSAL TWIN 130/705 H ZWI BR NE 6-100
- UNIVERSAL TWIN 130/705 H ZWI BR NE 8-100

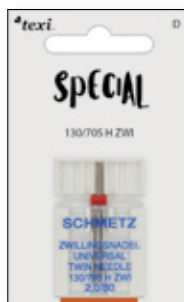

## TEXI COVERLOCK OVERLOCK

Igły do overloków i cowerloków



CENA I INFO



OVERLOCK/COVERLOCK ELX705 5x80  
OVERLOCK/COVERLOCK ELX705 5x90  
OVERLOCK/COVERLOCK ELX705 CF 5x65  
OVERLOCK/COVERLOCK ELX705 CF 5x80  
OVERLOCK/COVERLOCK ELX705 CF 5x90  
OVERLOCK/COVERLOCK ELX705 SUK CF 5x65  
OVERLOCK/COVERLOCK ELX705 SUK CF 5x80  
OVERLOCK/COVERLOCK ELX705 SUK CF 5x90



### TEXI CREATIVE 5

Igły do maszyn domowych MIX, 5 sztuk



CENA I INFO

### TEXI CREATIVE 9+

Igły do maszyn domowych MIX, 9 sztuk



CENA I INFO

### TEXI CREATIVE 10

Igły do maszyn domowych MIX, 10 sztuk



CENA I INFO



### TEXI JOY 13

Wieloczynnościowa maszyna do szycia,  
13 programów szycia



13 ŚCIEGÓW



4 STOPNIOWA  
DZIURKA

WYPOSAŻENIE  
MASZYNY



3 LATA  
GWARANCJI

BEZPIECZNA  
DLA DZIECKA

NAJLEPSZA  
NA START

## GLÓWNE FUNKCJE

- 13 zaprogramowanych ściegów (m.in. ściegi proste, zygaki i ozdobne)
- 4 stopniowa dziurka
- Regulacja długości (do 3,6 mm) i szerokości (do 4 mm) ściegu
- Szycie wstecz
- Maksymalna prędkość szycia 650 ściegów/min
- Zatraskowe mocowanie stopki – SYSTEM MATIC
- Łatwy system nawlekania
- Wolne ramię – łatwe szycie na okrągło
- Lampka LED
- Obcinacz nitki
- Chwytnacz wahadłowy

## WYPOSAŻENIE

stopka uniwersalna, stopka do obszywania dziurek, 2 szpulki, zestaw igieł, rozcinacz dziurek, uchwyt zabezpieczający szpulkę, rozrusznik nożny (pedał), oliwiarka, miękki pokrowiec



Wolne ramię do szycia na okrągło

**enjoy**  
YOUR COLOR!



## PAMIĘTAJ O:

### TEXI JOY 13 EXTENSION TABLE

Stół powiększający pole pracy  
o wymiarach: 22,5 cm x 32 cm



CENA I INFO



[www.strima.com](http://www.strima.com)

## TEXI GOLD

Wieloczynnościowa maszyna do szycia, 24 ściegi

NOWOŚĆ

3 LATA  
GWARANCIJ

AUTOMATYCZNE  
NAWLEKANIE  
NITKI

ŁATWA DO  
SZYCIA GRUBEGO  
MATERIAŁU



CENA I INFO



### WYPOSAŻENIE:

Zestaw 3 igieł + podwójna igła, wielofunkcyjny śrubokręt, szpulki (3 szt.), płytki hafciarska, przecinak/szczotka, stopka do guzików, prowadnik, stopka do zamków błyskawicznych, stopka do dziurek na guziki



# Gold | Servo Power

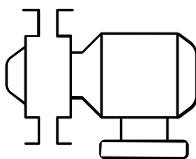

## REWOLUCJA W MASZYNACH DO SZYCIA

Silnik servo – większa moc i energia

### GŁÓWNE FUNKCJE:

- Silnik AC Servo
- 24 zaprogramowane ściegi (w tym proste, zygzak i dekoracyjne)
- 4-stopniowa dziurka
- Regulacja długości (do 3,6 mm) i szerokości (do 4 mm) ściegu
- Podnoszenie stopki 5 mm
- Szycie wstecz
- Prędkość szycia 700 ściegów/min
- Zatrzaskowe mocowanie stopki – SYSTEM MATIC
- Wolne ramię – łatwe szycie na okrągło
- Lampka (LED)
- Obcinacz nitki
- Chwytnacz wahadłowy
- Nawlekcacz igły



Wolne ramię – łatwe szycie na okrągło

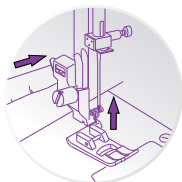

SYSTEM MATIC  
szybka wymiana  
stopki



## TEXI FOX 25

Wieloczynnościowa maszyna do szycia, 25 programów szycia

3 LATA  
GWARANCJI



CENA I INFO



### WYPOSAŻENIE:

stopka uniwersalna, stopka do wszywania zamków, stopka do obszywania dziurek, prowadnik, 3 szpulki, zestaw igieł, rozcinacz dziurek, pędzelek, śrubokręt, śrubokręt do płytki ścięgowej, rozrusznik nożny (pedał), oliwiarka, miękki pokrowiec

WYPOSAŻENIE  
MASZyny





## GŁÓWNE FUNKCJE

- 25 zaprogramowanych ściegów (w tym proste, zygzak i dekoracyjne)
- 4-stopniowa dziurka
- Regulacja długości (do 4 mm) i szerokości (do 4 mm) ściegu
- Podnoszenie stopki 5,5 mm
- Szycie wstecz
- Maksymalna prędkość szycia 700 ściegów/min
- Zatrzaśkowe mocowanie stopki – SYSTEM MATIC
- Wolne ramię – łatwe szycie na okrągło
- Lampka (LED)
- Obcinacz nitki
- Chwytnacz wahadłowy
- Nawlekacz igły

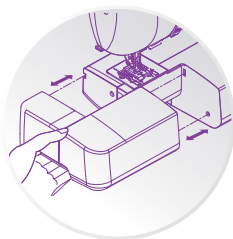
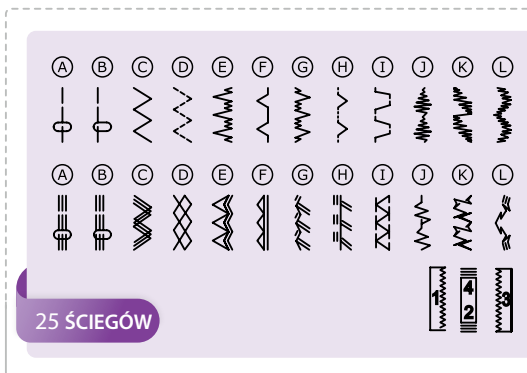

Wolne ramię – łatwe szycie na okrągło

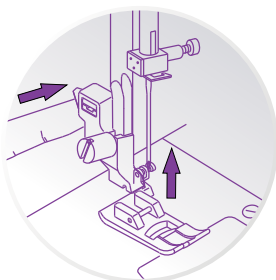

SYSTEM MATIC  
szybka wymiana stopki

## PAMIĘTAJ O:

### TEXI FOX 25 EXTENSION TABLE

Stolik powiększający pole pracy o wymiarach: 36 cm x 26 cm



CENA I INFO



## TEXI BRO

Wieloczynnościowa maszyna do szycia, 24 ścięgi

NOWOŚĆ

3 LATA  
GWARANCJI

AUTOMATYCZNE  
NAWLEKANIE  
NITKI

ŁATWA DO  
SZYCIA GRUBEGO  
MATERIAŁU



CENA I INFO

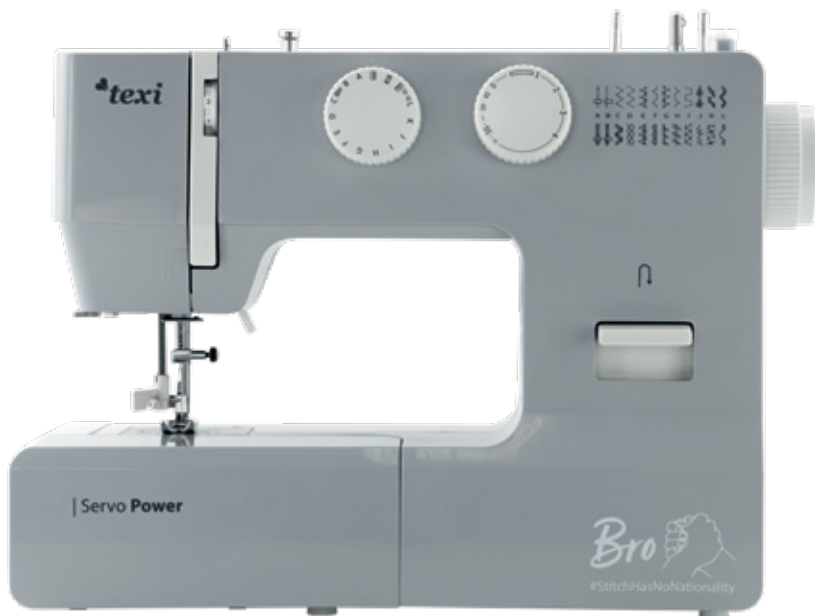

### WYPOSAŻENIE:

Zestaw 3 igieł + podwójna igła, wielofunkcyjny śrubokręt, szpulki (3 szt.), płytki hafciarska, przecinak/szczotka, stopka do guzików, prowadnik, stopka do zamków błyskawicznych, stopka do dziurek na guziki

WYPOSAŻENIE  
MASZYNY



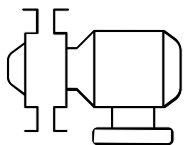

## REWOLUCJA W MASZYNACH DO SZYCIA

Silnik serwo - większa moc i energia



### GLÓWNE FUNKCJE:

- Silnik AC Servo
- 24 zaprogramowane ściegi (w tym proste, zygzak i dekoracyjne)
- 4-stopniowa dziurka
- Regulacja długości (do 3,6 mm) i szerokości (do 4 mm) ściegu
- Podnoszenie stopki 5 mm
- Szycie wstecz
- Prędkość szycia 700 ściegów/min
- Zatraskowe mocowanie stopki – SYSTEM MATIC
- Wolne ramię – łatwe szycie na okrągło
- Lampka (LED)
- Obcinacz nitki
- Chwytnacz wahadłowy
- Nawlekacz igły



Video



Wolne ramię – łatwe szycie na okrągło

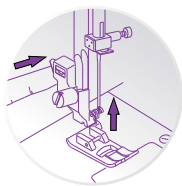

SYSTEM MATIC  
szybka wymiana  
stopki



## TEXI JOY 48

Wieloczynnościowa maszyna do szycia,  
48 programów szycia

3 LATA  
GWARANCJI



CENA I INFO



### WYPOSAŻENIE

stopka uniwersalna, stopka do wszywania zamków, stopka do obszywania dziurek, prowadnik, 3 szpulki, zestaw igieł, rozcinacz dziurek, pędzelek, śrubokręt, rozrusznik nożny (pedał), oliwiarka, miękki pokrowiec

WYPOSAŻENIE  
MASZYNY



## GŁÓWNE FUNKCJE

- 48 zaprogramowanych ściegów (m.in. ściegi proste, zygzaki i ozdobne)
- 4-stopniowa dziurka
- Regulacja długości (do 5 mm) i szerokości (do 5 mm) ściegu
- Elektroniczny wybór i regulacja szerokości ściegów
- Pozycjonowanie igły
- Podnoszenie stopki 5,5 mm
- Szycie wstecz
- Maksymalna prędkość szycia 700 ściegów/min
- Zatrzaskowe mocowanie stopki – SYSTEM MATIC
- Wolne ramię – łatwe szycie na okrągło
- Lampka (LED)
- Obcinacz nitki
- Chwytnacz wahadłowy



Wolne ramię do szycia na okrągło

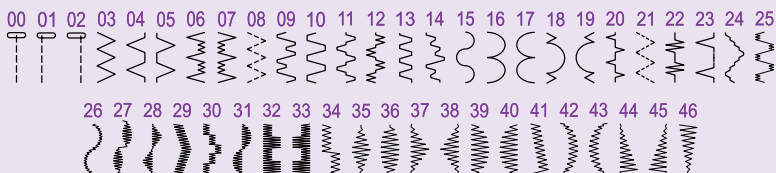
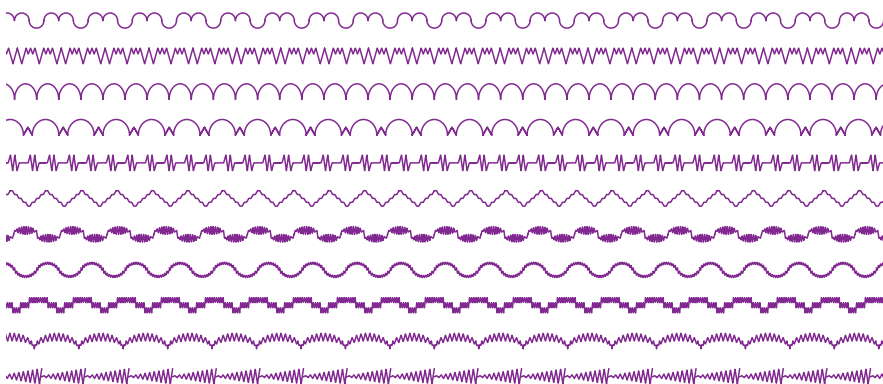

4 STOPNIOWA  
DZIURKA

48 ŚCIEGÓW

## TEXI BLACK&WHITE

Automatyczna, wieloczynnościowa maszyna do szycia sterowana komputerowo, 200 programów szycia

3 LATA  
GWARANCJI

NAJBOGATSZE  
WYPOSAŻENIE  
W STANDARDZIE

200  
PROGRAMÓW



CENA I INFO



### Wyposażenie:

zestaw igieł, igła podwójna, 4 szpulkki, rozcinacz dziurek ze szczotką, śrubokręt do płytki ścięgowej, nasadka szpulkki, śrubokręt, pomocniczy trzpień szpulkki, stopka do ściegu satynowego, stopka do wszywania zamków, stopka do ściegu krytego, stopka do guzików, stopka do obszywania dziurek, rozrusznik nożny (pedał)

WYPOSAŻENIE  
MASZYNY



## GŁÓWNE FUNKCJE

- 200 zaprogramowanych ściegów (m.in. 9 rodzajów automatycznego obszywania dziurki, ściegi proste, zygzaki, owerlokowe i ozdobne)
- Alfabet
- Płynna regulacja długości (do 4,5 mm) i szerokości ściegu (do 7 mm)
- Szycie wstecz
- Szycie podwójną igłą
- Maksymalna prędkość szycia 750 ściegów/min
- Elektroniczna regulacja prędkości szycia
- Wyświetlacz LCD
- Funkcja Start/Stop
- Pozycjonowanie igły (góra/dół)
- Automatyczny nawlekacz igły
- Zatraskowe mocowanie stopki - SYSTEM MATIC

Wolne ramię do szycia na okrągło



- Wolne ramię - łatwe szycie na okrągło
- Lampka LED
- Chwytnacz rotacyjny
- Metalowe podzespoły
- Wyłączany transport

## PAMIĘTAJ O:

### TEXI BLACK&WHITE EXTENSION TABLE

Stolik powiększający pole pracy 42 cm x 29 cm



CENA I INFO

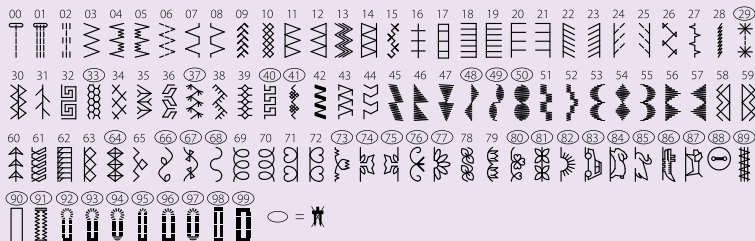

00 01 02 03 04 05 06 07 08 09 10 11 12 13 14 15 16 17 18 19 20 21 22 23 24 25 26 27 28 29 30 31 32 33 34 35 36 37 38 39 40 41 42 43 44 45 46 47 48 49 50 51 52 53 54 55 56 57 58 59 60 61 62 63 64 65 66 67 68 69 70 71 72 73 74 75 76 77 78 79 80 81 82 83 84 85 86 87 88 89 90 91 92 93 94 95 96 97 98 99

0 1 2 3 4 5 6 7 8 9 A B C D E F G H I J K L M N O P Q R S T U V W X Y Z a b c d e f g h i j k l m n o p q r s t u v w x y z @ ! ? & ' " , . - / : ; A A E a a e e é è ç œ ç | ñ ñ ö ö ø ø ù ù ù

200 ŚCIEGÓW

## TEXI BALLERINA

Automatyczna, wieloczynnościowa maszyna sterowana komputerowo, 200 programów szycia



CENA I INFO

### GŁÓWNE FUNKCJE

- 200 zaprogramowanych ściegów
- Alfabet
- Płynna regulacja dł. (do 5 mm) i szer. ściegu (do 7 mm)
- Szycie wstecz
- Elektroniczna regulacja prędkości szycia (maks. 750 ściegów/min)
- Przyciski:

usuwanie wzorów (CL), programowanie wzorów (ME), lustrzane odbicie (MI), powtarzanie wzorów (RE), start/stop, wolne szycie

- Pozycjonowanie igły (górną/dół)
- Szycie "ścieg po ściegu"
- Regulacja docisku stopki
- Wyłączany transport
- Zatraskowe mocowanie stopki – SYSTEM MATIC
- Wolne ramię – łatwe szycie na okrągło



### WYPOSAŻENIE

stolik powiększający pole pracy 50 x 38 cm, lampka LED, obcinacz nitki, nawlekacz igły, rozpruwacz z pędzelkiem, 4 szpulki, uchwyty szpulki (mały i duży), zestaw śrubokrętów, zestaw stopek, sztywne zabezpieczenie

DODATKOWO  
W ZESTAWIE

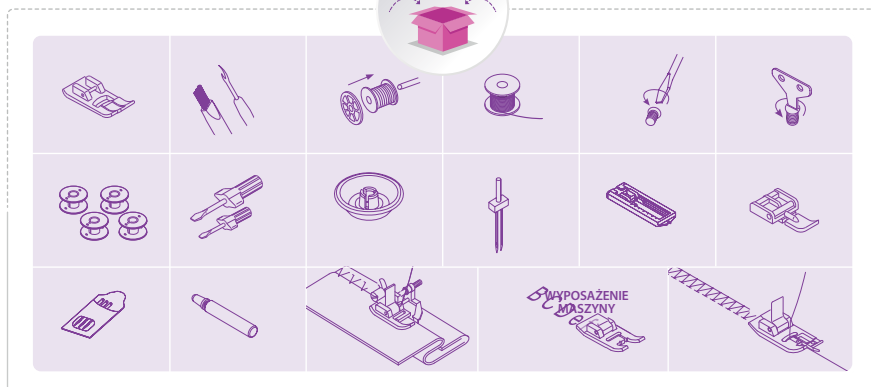





WOLNE RAMIE  
STANDARD  
XXL 50 X 38 cm

3 LATA  
GWARANCJI

NAJBOGATSZE  
WYPOSAŻENIE  
W STANDARDZIE

200  
PROGRAMÓW

001	002	003	004	005	006	007	008	009	010	011	012	013	014	015	016	017	018	019	020	021	022	023	024	025
026	027	028	029	030	031	032	033	034	035	036	037	038	039	040	041	042	043	044	045	046	047	048	049	050
051	052	053	054	055	056	057	058	059	060	061	062	063	064	065	066	067	068	069	070	071	072	073	074	075
076	077	078	079	080	081	082	083	084	085	086	087	088	089	090	091	092	093	094	095	096	097	098	099	100
101	102	103	104	105	106	107	108	109	110	111	112	113	114	115	116	117	118	119	120	121	122	123	124	125
126	127	128	129	130	131	132	133	134	135	136	137	138	139	140	141	142	143	144	145	146	147	148	149	150
151	152	153	154	155	156	157	158	159	160	161	162	163	164	165	166	167	168	169	170	171	172	173	174	175
176	177	178	179	180	181	182	183	184	185	186	187	188	189	190	191	192	193	194	195	196	197	198	199	200
p	q	r	s	t	u	v	w	x	y	z	[ ]	/	.	-	0	1	2	3	4	5	6	7	8	9

200 ŚCIEGÓW

## TEXI BALLERINA



Uszyj spódniczkę  
Pettitskirt  
Pobierz tutorial



**PAMIĘTAJ O:**

### TEXI ENJOY SEWING MACHINE BAG

Torba do domowych maszyn do szycia



CENA I INFO



### TEXI ENJOY MAXI SEWING MACHINE BAG

Torba do domowych maszyn do szycia, duża



CENA I INFO



### TEXI ENJOY OVERLOCK BAG

Torba do domowego overloka



CENA I INFO



### TEXI ENJOY MAXI OVERLOCK BAG

Torba do domowego overloka, duża



CENA I INFO



## TEXI JOYLOCK

2, 3, 4-nitkowy overlock do wszystkich rodzajów materiałów



CENA I INFO

3 LATA  
GWARANCJI

IDEALNY  
DO DZIANIN



WYPOSAŻENIE  
MASZYNY



## GŁÓWNE FUNKCJE

- 7 rodzajów ściegów overlokowych, m.in. ścieg rolujący (merezka)
- Transport różnicowy, regulowany w zakresie 0.7 – 2.0 mm
- Maksymalna prędkość szycia 1200 ściegów/min
- Długość ściegu 1 – 5 mm
- Szerokość ściegu do 6 mm
- Podnoszenie stopki do 6 mm
- Regulacja docisku stopki
- Zintegrowany mechaniczny obcinacz nitki ①
- Pojemnik na ścinki ②

- Zabezpieczenie przed uruchomieniem maszyny podczas nawlekania nici na chwytacz
- Regulacja szerokości obcinania materiału
- Wyłączany nóż górny
- Kolorowy system nawlekania nici

## WYPOSAŻENIE

lampka, 4 x podkładka pod szpulkę, 4 x osłona szpulki, 4 x uchwyt szpulki, pinceta, wkrętak x 2, klucz, pędzelek czyszczący, olej do maszyny, zestaw igieł, przewodnik nici, ślepy chwytacz, nóż ruchomy, rozrusznik nożny (pedał), miękki pokrowiec, torba na akcesoria



## PAMIĘTAJ O:

### TEXI 4079

Niezbędny zestaw do czyszczenia do maszyny do szycia



CENA I INFO

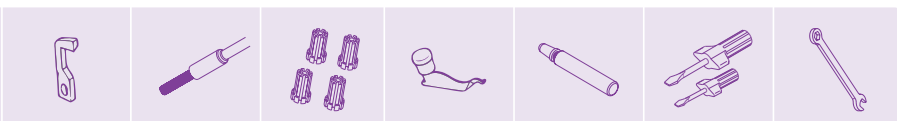

## RODZAJE ŚCIEGÓW

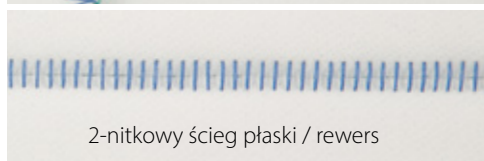
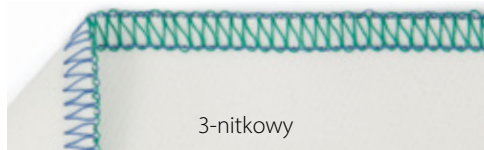
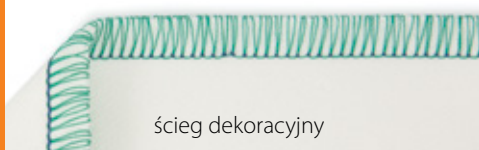
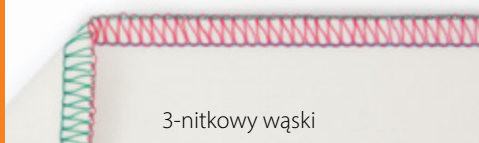
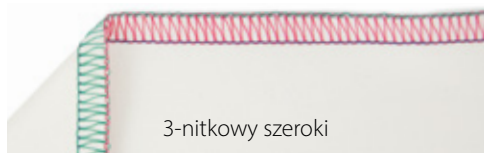
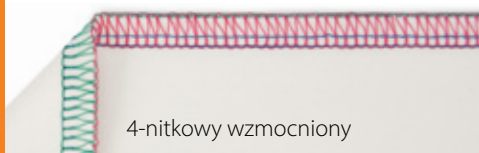

Pomyśl o zestawie stopek,  
które mogą Ci się przydać

**TEXI 1050**



CENA I INFO



## ŁATWE NAWLEKANIE

-  chwytacz dolny
-  chwytacz górny
-  igła prawa
-  igła lewa

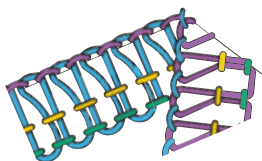

SZEROKIE OTWARCIE  
**PEŁNY DOSTĘP**  
DO CHWYTACZY

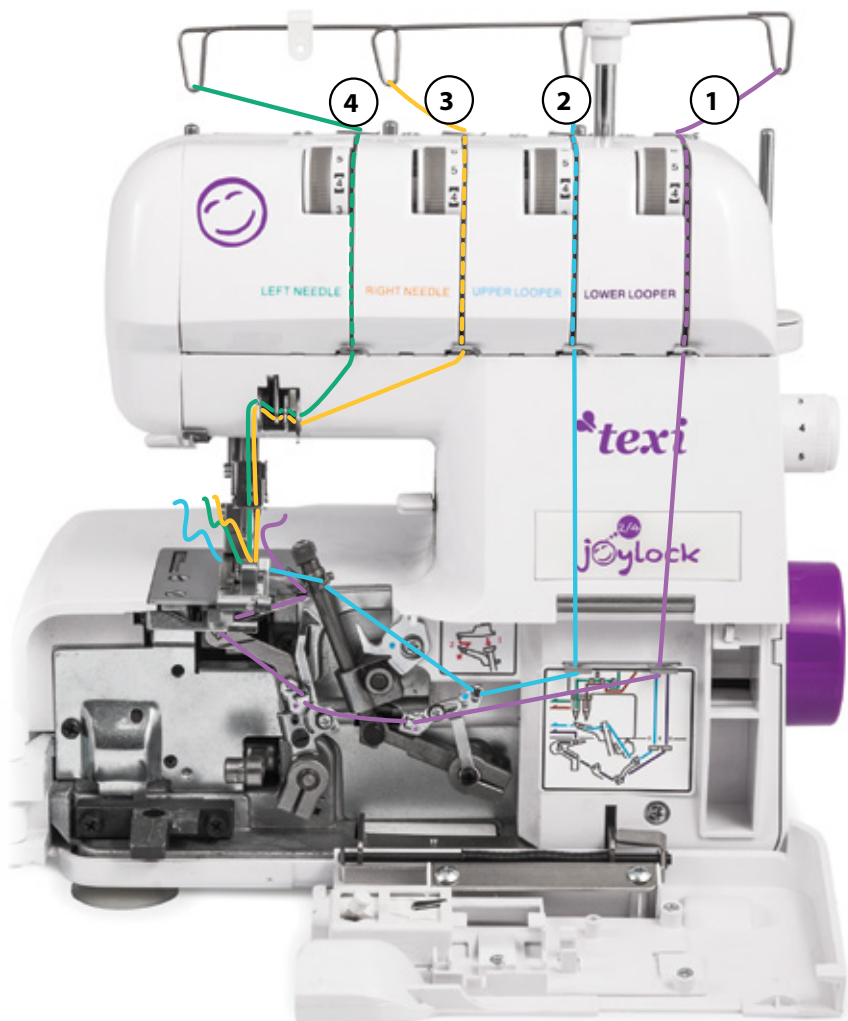

## TEXI TEGRA

2, 3, 4-nitkowy  
owerlok do wszystkich  
rodzajów materiałów



CENA I INFO

3 LATA  
GWARANCJI



Wolne ramię do szycia na okrągło

### WYPOSAŻENIE

Igły - 3 sztuki, tarcza szpulki,  
dolny nóż, prowadnik,  
pędzelek czyszczący,  
pinceta, 3 śrubokręty S, M, L,  
uchwyt na 2 igły, rozrusznik  
nożny (pedał), miękki  
pokrowiec

DODATKOWO  
W ZESTAWIE

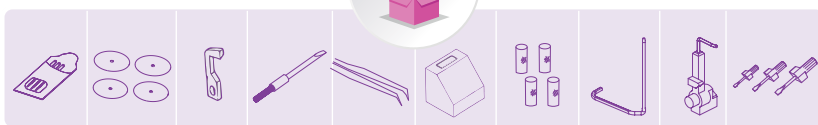



## 13 ŚCIEGÓW

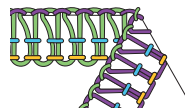

4 nitkowy, overlokowy

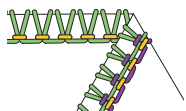

3-nitkowy overlokowy szeroki

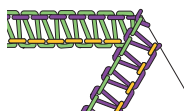

3-nitkowy overlokowy wąski

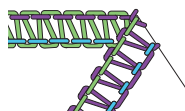

overlokowy, obrzucający 3-nitkowy szeroki

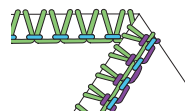

overlokowy, obrzucający 3-nitkowy wąski

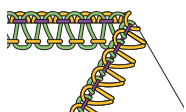

3-nitkowy dekoracyjny

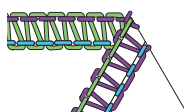

3-nitkowy marszczony

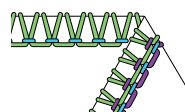

3-nitkowy marszczony, overlokowy



2-nitkowy overlokowy, szeroki



2-nitkowy overlokowy, wąski

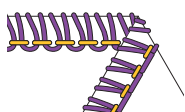

overlokowy 2-nitkowy szeroki

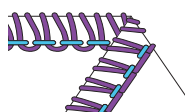

overlokowy 2-nitkowy, wąski, mierzka

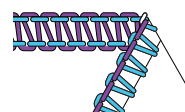

2-nitkowy marszczony, mierzka

## GŁÓWNE FUNKCJE

- Liczba nici overloka: 2, 3 lub 4
- Szerokość ściegu: do 6,7 mm
- System igieł: 130/705H (HA1x 1)
- Długość ściegu: 1 - 4 mm
- Maksymalna prędkość szycia 1200 ściegów/min
- Podnoszenie stopki do 4 mm
- Regulacja transportu różnicowego w zakresie od 0,7 do 2,0 mm
- Regulacja docisku stopki
- Manualny obcinacz nitki
- Pojemnik na ścinki materiału
- Ślepy chwytacz
- Regulacja szerokości cięcia
- Możliwość wyłączenia górnego noża
- Łatwy i czytelny (kolorowy) system nawlekania
- Lampka (LED)
- Mechanizm zwalniający naprężenie nici
- Wolne ramię do szycia na okrągło

# texi. Rozkładana szafka na dwie maszyny

## TEXI SESAME DUO



Pracownia krawiecka w jednej szafce? Kredki, nożyczki, miarka, rozcinacz do dziurek, szpilki, igły, nici, pinceta, szpulki, stopki, prowadniki i inne akcesoria krawieckie w jednym miejscu. No i najważniejsze - maszyna i overlock także. Robisz klik i maszyna do szycia jak za dotknięciem czarodziejskiej różdżki wyłania się spod blatu, a półkę z overlockiem wysuwasz jednym ruchem ręki. Jak skończysz, robisz klap, klap, klap i... masz wszystko uporządkowane w zamkniętej szafce.



Zobacz szafkę w akcji



## Manekin krawiecki - regulowany



Zakres regulacji	36 - 42	42 - 48
obwód szyi	35 - 46 cm	35 - 46 cm
obwód biustu	84 - 100 cm	101 - 117 cm
obwód talii	64 - 80 cm	77 - 97 cm
obwód bioder	86 - 102 cm	102 - 119 cm



CENA I INFO

**TEXI DRESS FORM 36-42**  
**TEXI DRESS FORM 42-48**



# **texi.** Akcesoria do maszyn domowych

## **TEXI 0008**

Stopka do wszywania zamków krytych, wysokie mocowanie



CENA I INFO



## **TEXI 0009**

Stopka do haftowania, cerowania i pikowania



CENA I INFO



## **TEXI 0010**

Stopka do zszywania i marszczenia



CENA I INFO

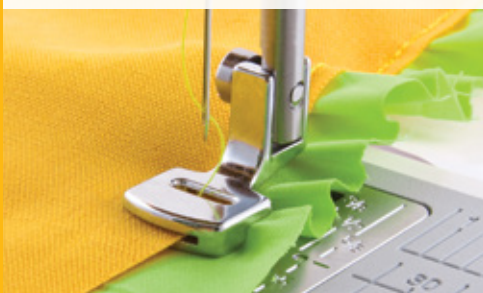

## **TEXI 0011**

Stopka do marszczenia



CENA I INFO



## **TEXI 0012**

Stopka do naszywania aplikacji



CENA I INFO

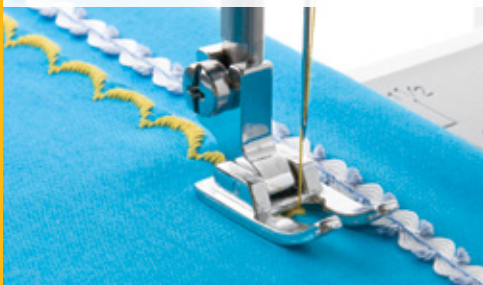

## **TEXI 0013**

Stopka z rolkami do trudnych materiałów



CENA I INFO



### TEXI 0014

Stopka do krawędziowego  
łączenia dwóch tkanin



CENA I INFO



### TEXI 0019

Stopka dwustronna, szeroka  
do wszywania zamków  
i szycia krawędziowego



CENA I INFO



Stopka dwustronna, wąska do wszywania  
zamków

### TEXI 0017

Niski typ mocowania



CENA I INFO



### TEXI 0018

Wysoki typ mocowania



CENA I INFO

### TEXI 0023

Stopka do wyszywania  
ozdobnych motywów  
"na okrągło"



CENA I INFO



### TEXI 0022

Stopka do zakładki  
i marszczenia



CENA I INFO



### TEXI 0024

Stopka z górnym transportem ułatwiająca szycie wielu warstw materiału



CENA I INFO



### TEXI 0025

Stopka overlokowa do jednoczesnego obrzucania i obcinania materiału



CENA I INFO



### TEXI 0026

Stopka do naszywania ozdobnych sznurków



CENA I INFO

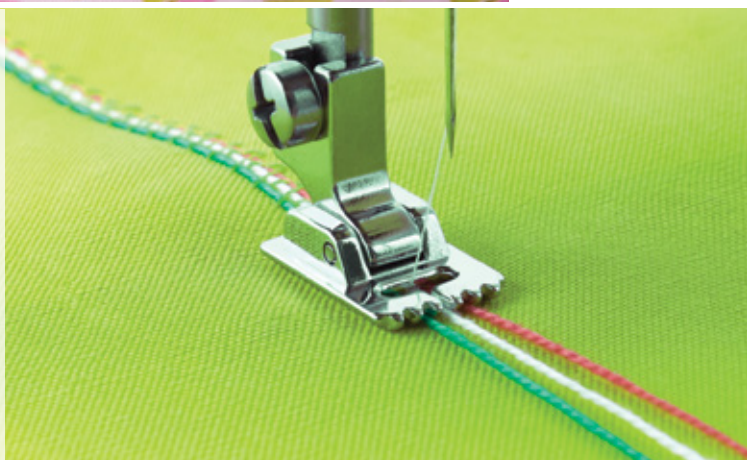

# System MATIC

Zmieniaj stopki w 5 sekund!

Zmierz wysokość od dołu stopki do śruby mocującej uchwyt stopki.

Jeśli odległość wynosi około **1,5 cm** – oznacza to, że mamy niski typ mocowania stopki. Dotyczy większości maszyn.

Jeżeli odległość wynosi około **2,5 cm** – jest to wysoki typ mocowania stopki.



MATIC

## TEXI 1001

Niskie mocowanie  
wysokość (1,5 cm)

## TEXI 1002

Wysokie mocowanie  
wysokość (2,5 cm)



Niskie



Wysokie



## TEXI 1003

Stopka uniwersalna  
do ściegu prostego  
i zygzakowego



CENA I INFO



## TEXI 1004

Stopka wzmacniona  
plastikowa do ściegu  
prostego i zygzakowego



CENA I INFO

MATIC

### TEXI 1005

Stopka do  
4-stopniowego  
obszywania dziurek



CENA I INFO

### TEXI 1006

Stopka do naszywania  
aplikacji, szycia ścięgiem  
satynowym



CENA I INFO

### TEXI 1008

Stopka do  
przyszywania  
guzików



CENA I INFO



**TEXI 1009**

Stopka dwustronna  
do wszywania  
zmków



CENA I INFO

**TEXI 1010**

Stopka podwójnie  
zwijająca 1/16"  
(1,6 mm)



CENA I INFO

**TEXI 1011**

Stopka  
z regulowanym  
prowadnikiem



CENA I INFO

**TEXI 1012**

Stopka do naszywania ozdobnych sznurków i gumek



CENA | INFO

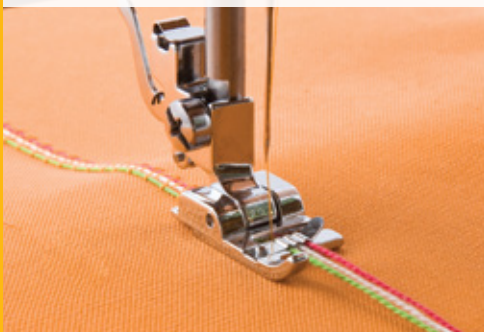

**TEXI 1013**

Stopka do ścięgu overlokowego



CENA | INFO

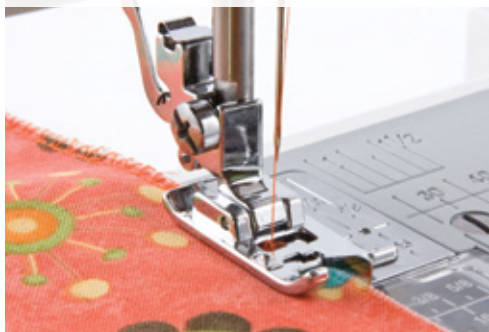

**TEXI 1014**

Prowadnik krawędziowy idealny do pikowania



CENA | INFO



**TEXI 1015**

Stopka do wszywania zamków krytych



CENA | INFO



**TEXI 1016**

Stopka z rolkami do trudnych „klejących się” materiałów



CENA | INFO



**TEXI 1017**

Stopka do wszywania zaprasowanej lamówki, regulowana 5 -20 mm



CENA | INFO





### TEXI 2001

Uchwyt mocujący  
lamowniki i zwijacze



CENA I INFO

## LAMOWNIKI

## ZWIJACZE



### TEXI 2002

A = 7/32" (5,5 mm)

### TEXI 2003

A = 1/10" (2,5 mm)

### TEXI 2004

A = 1/4" (6,4 mm)

### TEXI 2005

A = 3/8" (9,5 mm)

### TEXI 2006

A = 5/8" (16 mm)

### TEXI 2007

A = 7/8" (22 mm)

# **texi**. Uniwersalne akcesoria



## **TEXI 3003 SET 3**

Zestaw 3 szpulek metalowych, płaskich



CENA | INFO



## **TEXI 3004 SET 3**

Zestaw 3 szpulek plastikowych, płaskich



CENA | INFO



## **TEXI 3010 SET 3**

Zestaw 3 szpulek plastikowych, soczewkowych



CENA | INFO



## **TEXI 4005**

Pinceta



CENA | INFO



## **TEXI 4033**

Pudełko do przechowywania 25 szpulek



CENA | INFO



## **TEXI 4079**

Zestaw do czyszczenia maszyny do szycia



CENA | INFO

### TEXI 4047

Przyrząd do wywracania pasków i szlufek oraz przeciągnięcia sznurka



CENA I INFO

### TEXI 4083

Rozcinacz dziurek, rozpruwacz



CENA I INFO

### TEXI 4049

Igła do przeciągnięcia nitki



CENA I INFO

### TEXI 4048

Przyrząd do ręcznego wygładzania szwów



CENA I INFO



### TEXI 4013

Kredka do tkanin:  
biała i kolor



CENA I INFO



### TEXI 4014

Pisak znikający  
fioletowo-różowy



CENA I INFO



### TEXI 4015

Pisak znikający:  
fioletowy lub różowy



CENA I INFO



### TEXI 4016

Korektor pisaków  
znikających



CENA I INFO



### TEXI 4040

Kredka krawiecka w aplikatorze



CENA I INFO



### TEXI 4041

Kredka krawiecka -  
wkład do aplikatora



CENA I INFO



### TEXI 4075

Szpilki stalowe niklowane, główki w kształcie kwiatków 48 x 0,6 mm opakowanie 80 szt.



CENA I INFO



### TEXI 4076

Szpilki stalowe niklowane ze szklanymi główkami 48 x 0,6 mm opakowanie 75 szt.



CENA I INFO

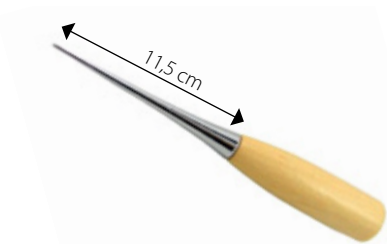

### TEXI 4046

Narzędzie do wykonywania otworów na nity, zatrzaski, oczka itp.



CENA I INFO



### TEXI 4034

Nawlekcacz nitki



CENA I INFO



### TEXI 4029

Magnetyczna poduszka do igieł i szpilek



CENA I INFO



### TEXI 4082

Rozcinacz ścięgu, 2 szt.



CENA I INFO



### TEXI 4080

Zestaw sprytnych akcesoriów dla każdej krawcowej



CENA I INFO

### TEXI 4011

Szczotka do podnoszenia włosa



CENA I INFO

### TEXI BOX 15

Pudełko z motylami zawiera: 15 szpułek nici w różnych kolorach, 5 igieł i przewodnik po igłach Texi



CENA I INFO

### TEXI 4006

Rolka czyszcząca z uchwytem (1 rolka = 10 m)



CENA I INFO

### TEXI 4006R

Rolka wymienna





### TEXI 4035

Zestaw 3 zwijaczy  
do zaprasowywania  
lamówki



CENA I INFO



A = 24 mm, B = 12 mm

**TEXI 4036**

A = 36 mm, B = 18 mm

**TEXI 4037**

A = 50 mm, B = 25 mm

**TEXI 4038**



### TEXI 4020

Sztyft do czyszczenia stóp  
żelazek suchych i parowych



### TEXI 4001

Nakładka  
przeciwpołyskowa

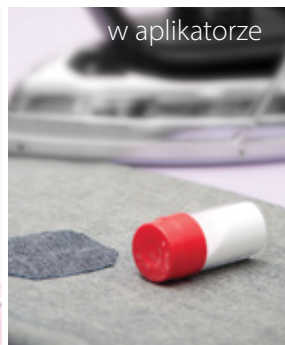

### TEXI 4002

Proszek termoprzylepny  
do podklejania  
brzegów materiału



CENA I INFO



CENA I INFO



CENA I INFO

# texi. Craft Maty podkładowe i linijki

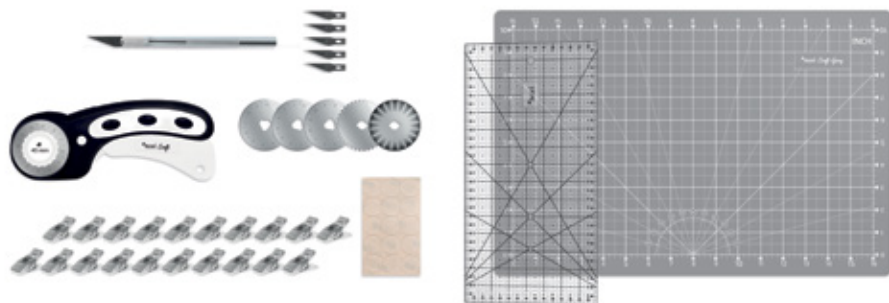

## TEXI CRAFT GRAY 45X30

Komplet narzędzi do cięcia - nóż krążkowy z zapasowymi ostrzami, mata samoregenerująca (5-warstwowa, nóż rzemieślniczy z dodatkowymi ostrzami, klipsy oraz naklejki antypoślizgowe.



CENA I INFO

## Zestawy w różnych kolorach



**TEXI CRAFT  
PINK 60 X 45 SET**

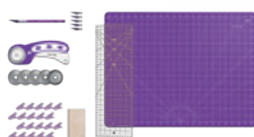

**TEXI CRAFT  
PURPLE 60 X 45 SET**

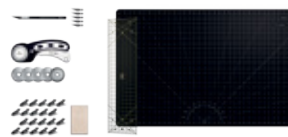

**TEXI CRAFT  
BLACK 90 X 60 SET**

## Linijki do patchworku i quiltingu

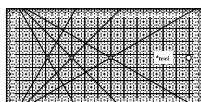

15 x 30 cm, czarny

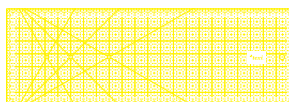

15 x 45 cm, żółty

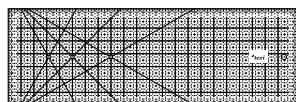

15 x 45 cm, czarny

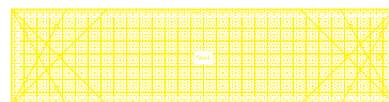

15 x 60 cm, żółty

## TEXI 4097

Klipsy do szycia  
38 x 11 x 15 mm  
różne kolory, 20 szt.



CENA I INFO

## TEXI 4106

Nóż krążkowy  
Ø45 mm



CENA I INFO

## TEXI 4107

Nóż kraft



CENA I INFO

Jakie ostrze potrzebne? Proste, ząbkowane, faliste?

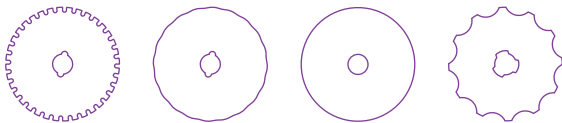

CENA I INFO

## Maty podkładowe



CENA I INFO

### TEXI GRAY

45 x 30 cm  
60 x 45 cm  
90 x 60 cm

### TEXI BLUE

45 x 30 cm  
60 x 45 cm  
90 x 60 cm

### TEXI PINK

45 x 30 cm  
60 x 45 cm  
90 x 60 cm

### TEXI BLACK

45 x 30 cm  
60 x 45 cm  
90 x 60 cm

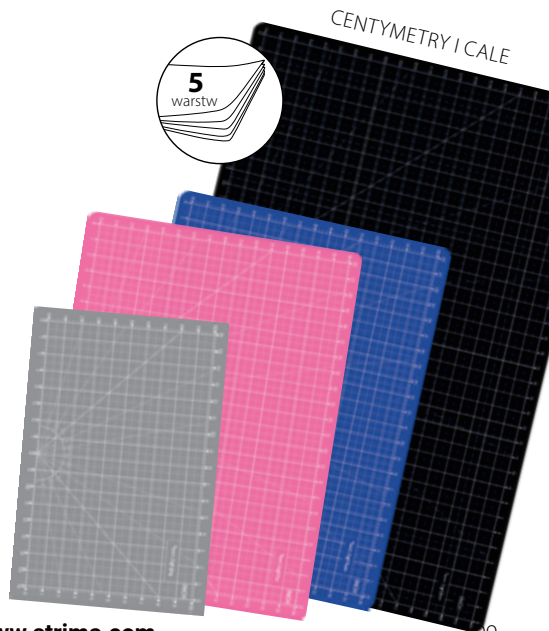

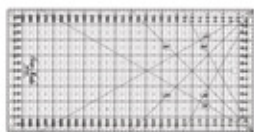

### TEXI 4065

Liniał do quiltingu,  
patchworku, 160x320 mm,  
podziałka cm, czarna



CENA I INFO

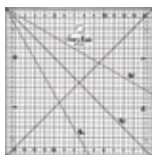

### TEXI 4066

Liniał do quiltingu,  
patchworku, 160x160 mm,  
podziałka cm, czarna



CENA I INFO



### TEXI 4067

Liniał do quiltingu,  
patchworku, 160x320 mm,  
podziałka cm, żółta



CENA I INFO

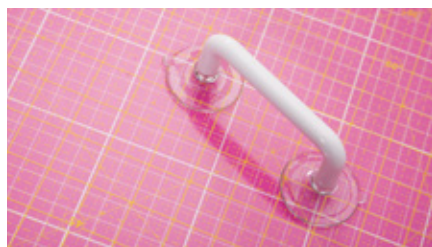

### TEXI 4068

Uchwyt do liniałów,  
podwójny



CENA I INFO



### TEXI 4069

Uchwyt do liniałów,  
pojedynczy



CENA I INFO



### TEXI 4007

Miara krawiecka  
z podziałką centymetrową,  
dł. 150 cm, szer. 19 mm



CENA I INFO



### TEXI 4008

Miara krawiecka  
zwijana automatycznie,  
dwustronna 150 cm



CENA I INFO



CENA I INFO



## *texi* Noże krążkowe



**TEXI 4050**  
Ø 18 mm



**TEXI 4051**  
Ø 28 mm



**TEXI 4053**  
Ø 45 mm



**TEXI 4054**  
Ø 60 mm

OSTRZA DO NOŻY



proste



skokowe



faliste

Ø 18 mm	Ø 28 mm	Ø 45 mm	Ø 60 mm
— <b>TEXI 4055</b>	— <b>TEXI 4056</b> - - <b>TEXI 4058</b> ~~~~ <b>TEXI 4059</b>	— <b>TEXI 4057</b>	— <b>TEXI 4060</b>

PATCHWORK

# texi. Prasowanie



MODEL	POWIERZCHNIA	REGULACJA WYSOKOŚCI	NAPIĘCIE	MOC ŻELAZKA	ODSYSANE	MOC TURBINY	MOC WYTWORNICY PARY	WSZYSTKO W JEDNYM PALCU	PRASULEC
TEXI BIB	40 x 120 cm	81 - 100 cm	-	-	-	-	-	-	-
TEXI CHAMPION SB	45 x 120 cm	85 - 102 cm	400 W	-	35 W	35 W	-	-	-
TEXI SMART S+B	45 x 120 cm	60 - 105 cm	200 W	800 W	40 W	40 W	1 300 W	✓	✓

## TEXI SLEEVE BUCK

Prasulec rękawowy uniwersalny,  
długość 52 cm



CENA I INFO



## TEXI BIB

Stół typu deska  
40 x 120 cm



CENA I INFO



Podgrzewanie Odsysanie Nadmuchi



85 - 102 cm



CENA I INFO

## TEXI CHAMPION SB

Stół typu deska 45 x 120 cm,  
z odsysaniem, nadmuchiem i  
podgrzewaną powierzchnią

## TEXI SMART S+B

Stół prasowniczy z automatyczną, zintegrowaną wytwornicą pary, żelazkiem i inteligentnym programowaniem czasu pracy turbiny



CENA I INFO

Podgrzewanie



Odsysanie



Nadmuch



TEXI 1081



TEXI SMART  
S+B BRUSH



60 - 105 cm

**texi** Praski



**TEXI FLAT HEAT  
PRESS 40X60**

Pole pracy  
40 x 60 cm



**TEXI FLAT HEAT  
PRESS 38X38**

Pole pracy  
38 x 38 cm



**TEXI MUG  
HEAT PRESS**

Do kubków



**TEXI CAP HEAT  
PRESS**

Do czapek  
Pole pracy 10 x 20 cm



# texi. Prasownice parowe



DIGITAL CONTROL



Prasownica parowa sterowana elektronicznie

## TEXI APOLLO 68

Powierzchnia prasownicza  
66 x 26 cm, 1600 W

## TEXI APOLLO 101

Powierzchnia prasownicza  
99 x 29 cm, 2200 W



CENA I INFO

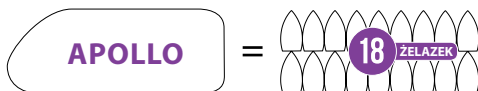
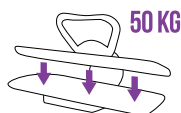

## TEXI AP01

Podstawa do prasownic Apollo,  
wysokość 93 cm



CENA I INFO

## TEXI AP02

Podstawo do prasownic Apollo  
teleskopowa wysokość  
regulowana 63 - 73 cm



CENA I INFO

1  
2  
3  
4  
5  
6  
7  
8  
9  
10  
11  
12  
13  
14  
15  
16  
17  
18  
19

**texi.** *Black Turbo*



CENA I INFO

Ubrania  
Tekstylna  
Meble tapicerowane  
Dywany



Niesamowite  
ciśnienie



Szybki  
czas startu



155°C

Temperatura  
pary



Łatwy  
do przenoszenia



Funkcja  
nagrzewania  
stopy głowicy



Usuwa  
bakterie

## IDEALNY DLA PROFESJONALISTÓW

Stworzony do prasowania i odświeżania sukienek, płaszczy, garniturów oraz elementów dekoracyjnych, w tym zasłon i dywanów. Sprawdzi się do sztucznych futer i mebli tapicerowanych. Niezastąpiony w pracowni krawieckiej, hotelu, pralni czy butiku odzieżowym. Doskonale sprawdzi się też w gastronomii, np. przy prasowaniu obrusów.

## FUNKCJONALNOŚĆ I DESIGN

Solidna konstrukcja, wysoka jakość materiałów, staranne wykończenie i ergonomiczne rozmieszczenie przycisków gwarantują trwałość i wygodę korzystania z parowca.

Parowiec Texi łączy wszechstronność funkcji z intuicyjną obsługą i eleganckim wyglądem. Duże kółka nadają mu mobilność, dzięki czemu będzie niezastąpiony podczas eventów, targów czy organizacji imprez i ślubów w plenerze.

## IDEALNY DLA ALERGIKÓW

Dzięki oczyszczającym właściwościom gorącej pary Texi Black Turbo usuwa alergeny, grzyby, bakterie i pyłki z tkanin i tekstyliów, dzięki temu pomaga w utrzymaniu czystego i zdrowego otoczenia oraz ogranicza dolegliwości związane z alergią.

## BOGATE WYPOSAŻENIE



Wieszak



Nakładka do prasowania mankietów



Nakładka do prasowania kołnierzyków



Nakładka do delikatnych tkanin



Nakładka do szczotkowania



Rękawica

W standardowym wyposażeniu Texi Black Turbo znajdziesz nasadki do prasowania kołnierzyków, brzegów spodni i klap marynarek oraz specjalną szczotkę do odświeżania tkanin pluszowych, dywanów i mebli tapicerowanych. Dodatkowo posiada "deskę do prasowania" ułatwiającą i przyspieszającą prasowanie większych powierzchni, a także praktyczny wieszak z klamrami do zamocowania np. nogawek spodni oraz nakładkę do delikatnych tkanin, która zabezpiecza materiał przed bezpośrednim kontaktem z gorącą powierzchnią głowicy.



**TEXI 75S TAG GUN**

Pistolet do etykietowania – standard



CENA I INFO

**TEXI 75F TAG GUN**

Pistolet do etykietowania z cięższą igłą do delikatnych materiałów – fine



standard



fine



CENA I INFO

Igły do pistoletów



**TEXI 75S  
NEEDLE**

Standard 1,85 mm



**TEXI 75F  
NEEDLE**

Fine 1,32 mm



**TEXI 75S N  
EEDLE PREMIUM**

Standard 1,85 mm



**TEXI 75F  
NEEDLE PREMIUM**

Fine 1,32 mm



CENA I INFO



## Nitki do etykietowania

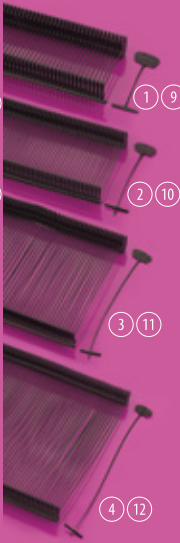

### TEXI 75 PPS STANDARD

1	TEXI 75 PPS BLACK 015	15 mm
2	TEXI 75 PPS BLACK 025	25 mm
3	TEXI 75 PPS BLACK 045	45 mm
4	TEXI 75 PPS BLACK 065	65 mm
5	TEXI 75 PPS NEUTRAL 015	15 mm
6	TEXI 75 PPS NEUTRAL 025	25 mm
7	TEXI 75 PPS NEUTRAL 045	45 mm
8	TEXI 75 PPS NEUTRAL 065	65 mm

### TEXI 75 PPF FINE

9	TEXI 75 PPF BLACK 015	15 mm
10	TEXI 75 PPF BLACK 025	25 mm
11	TEXI 75 PPF BLACK 045	45 mm
12	TEXI 75 PPF BLACK 065	65 mm
13	TEXI 75 PPF NEUTRAL 015	15 mm
14	TEXI 75 PPF NEUTRAL 025	25 mm
15	TEXI 75 PPF NEUTRAL 045	45 mm
16	TEXI 75 PPF NEUTRAL 065	65 mm

## Nitki do ręcznego etykietowania

**TEXI 75 PP SECUR LOOP 130**  
**TEXI 75 PP SECUR LOOP 230**



Światowy dystrybutor 

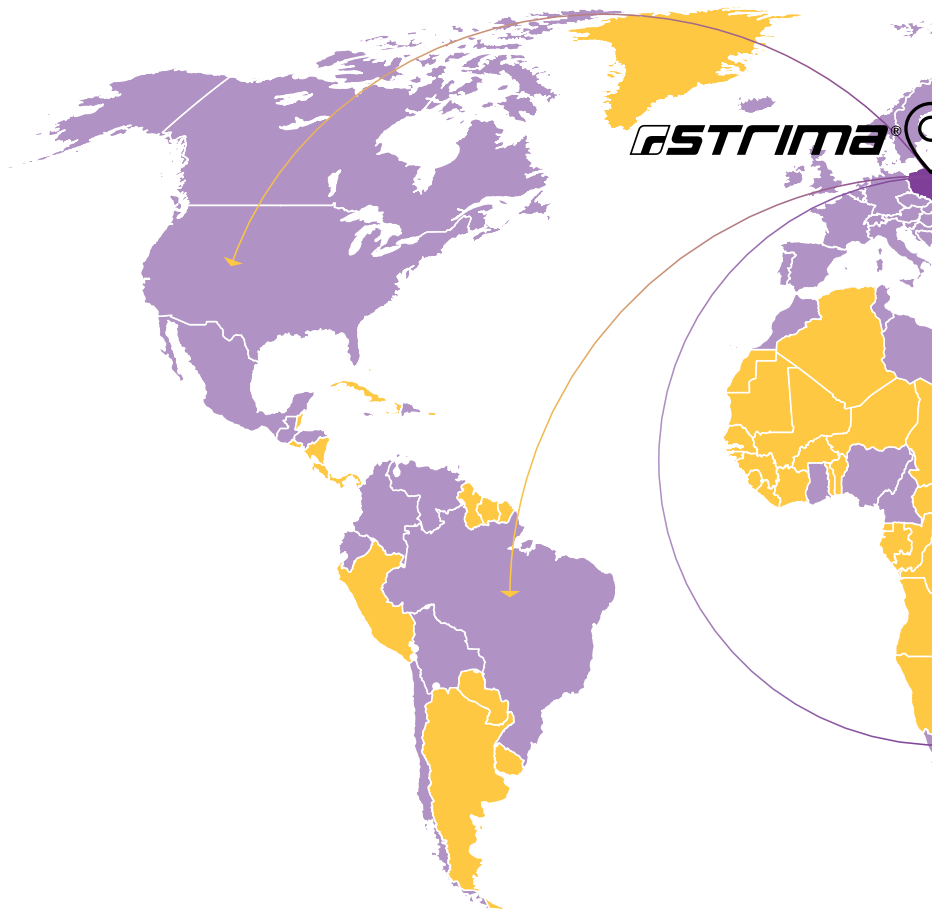

## Strima Centrala

+48 61 8 950 950  
shop@strima.com

Swadzim k/Poznania, ul. Poznańska 54  
62-080 Tarnowo Podgorne

[www.strima.com](http://www.strima.com)

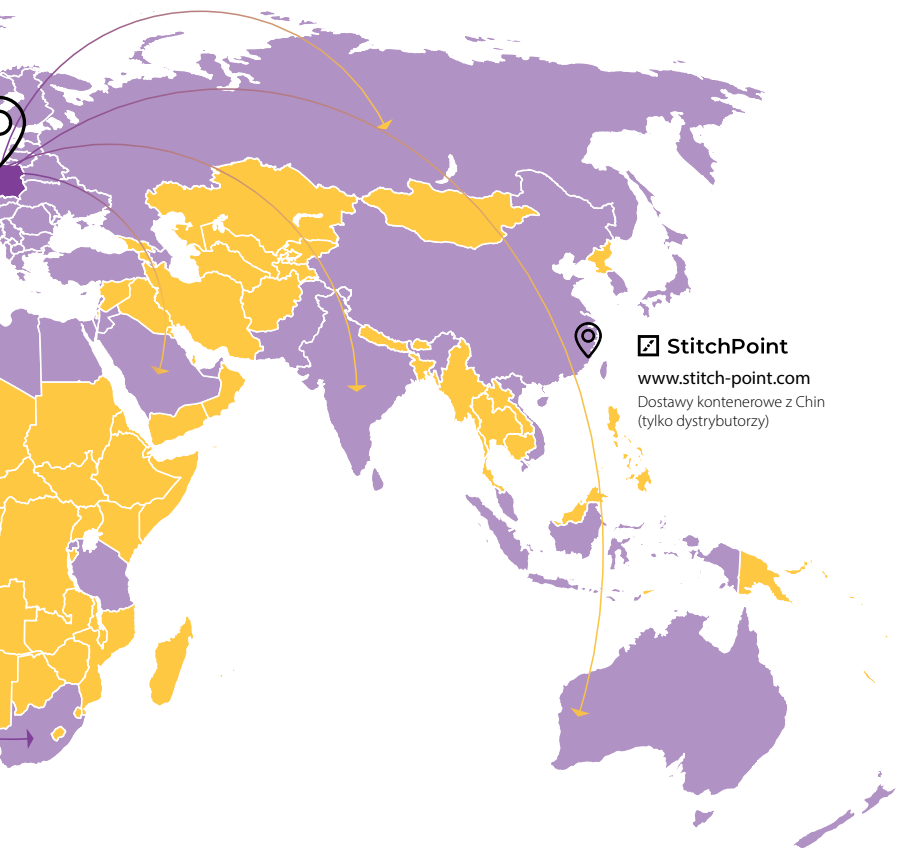

 **StitchPoint**

[www.stitch-point.com](http://www.stitch-point.com)

Dostawy kontenerowe z Chin  
(tylko dystrybutorzy)

